

THE DARKSIDE

DARK MATTER PROGRAM

LEPP JOURNAL CLUB, CORNELL UNIVERSITY

MARCH 13TH, 2012

ALEX WRIGHT

PRINCETON UNIVERSITY

Outline

- Dark matter review
 - Evidence & known properties
- Searching for dark matter
 - Direct detection experiments
- The DarkSide experiment
 - Strategy
 - Technical progress
 - Future
- Testing the DAMA experiment

Evidence for Dark Matter

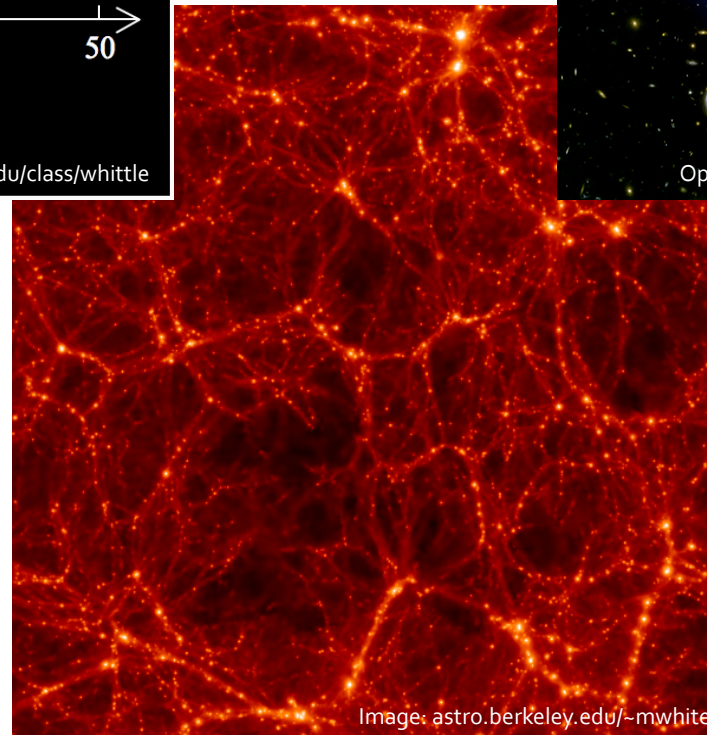
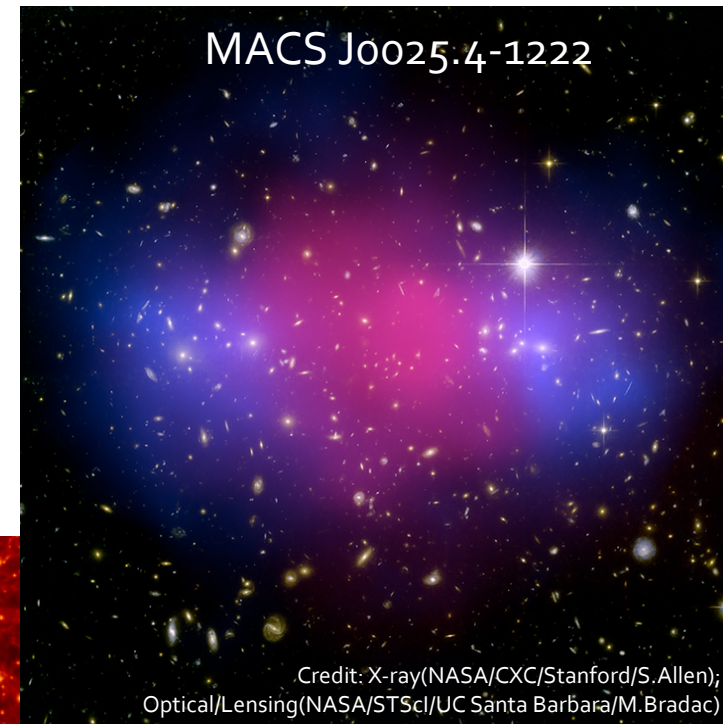
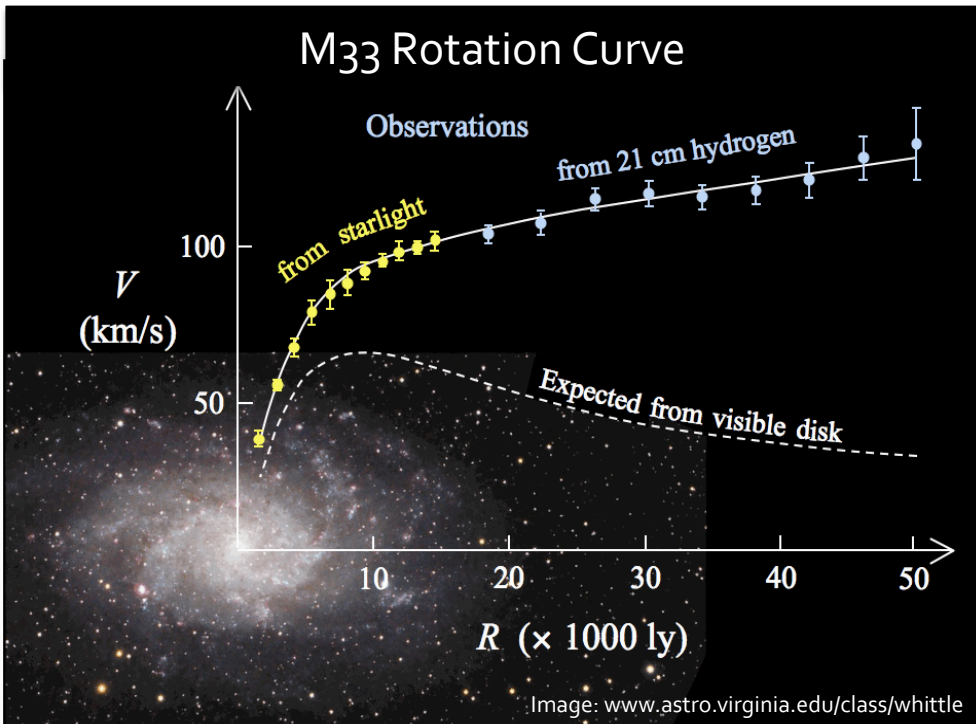

Evidence for Dark Matter

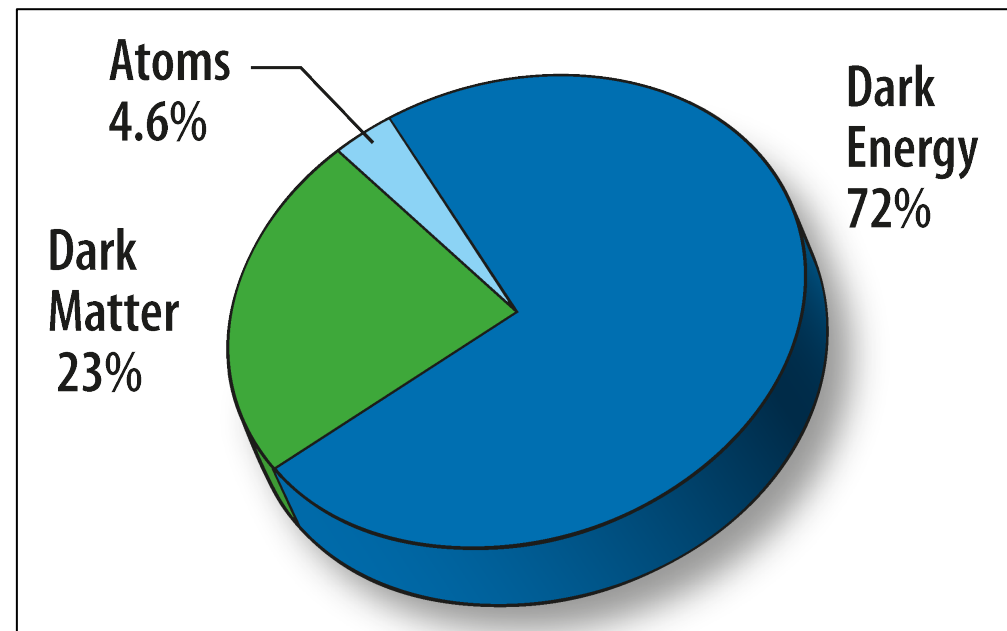
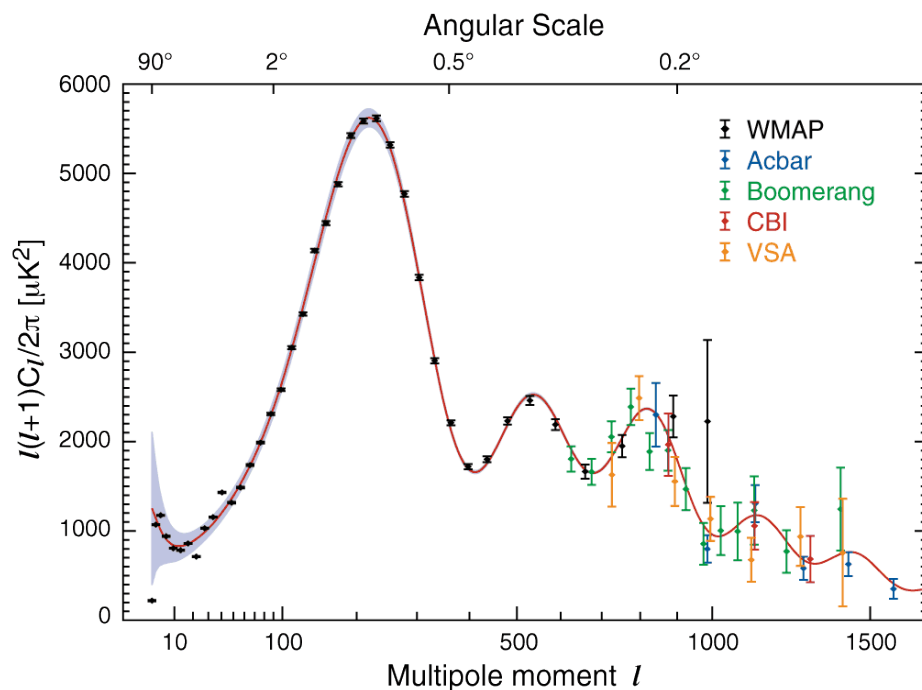
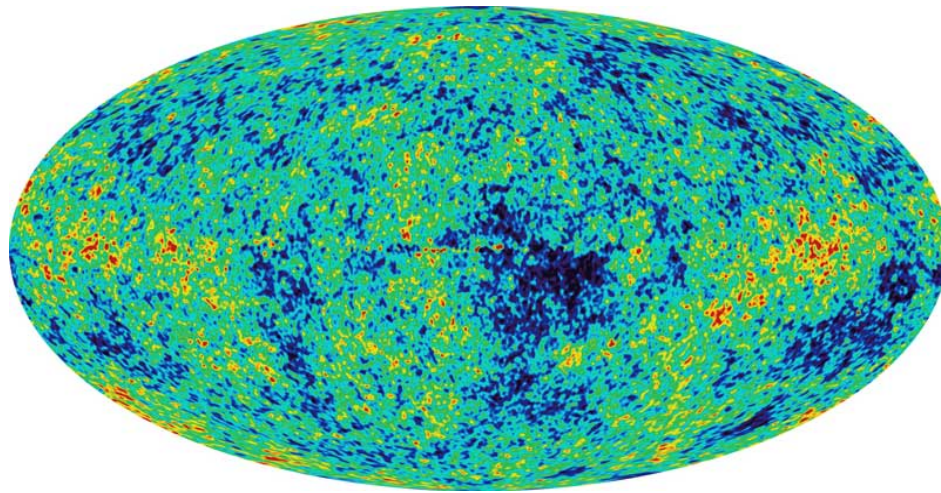

Dark Matter Properties

- ~23% of the energy density of the universe is “dark matter”
 - Gravitationally interacting
 - Neutral
 - Long lived
 - Non-baryonic
 - “Cold” (i.e. non-relativistic at early times)

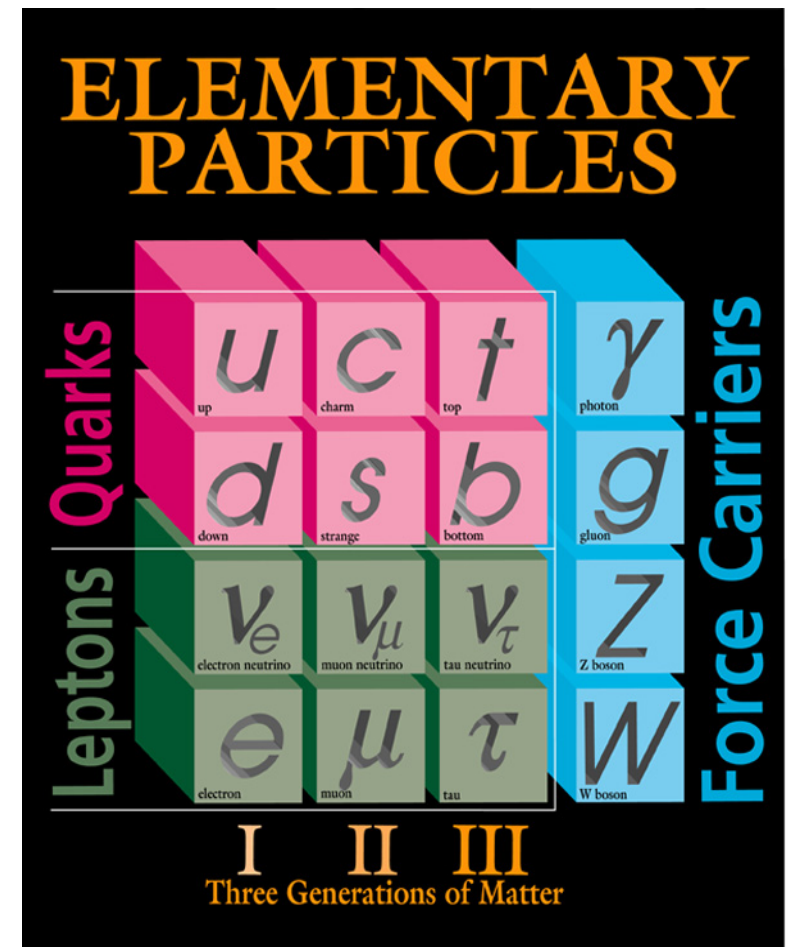

Dark Matter Properties

- ~23% of the energy density of the universe is dark matter
 - Gravitationally interacting
 - Neutral
 - Long lived
 - Non-baryonic
 - “Cold” (i.e. non-relativistic at early times)

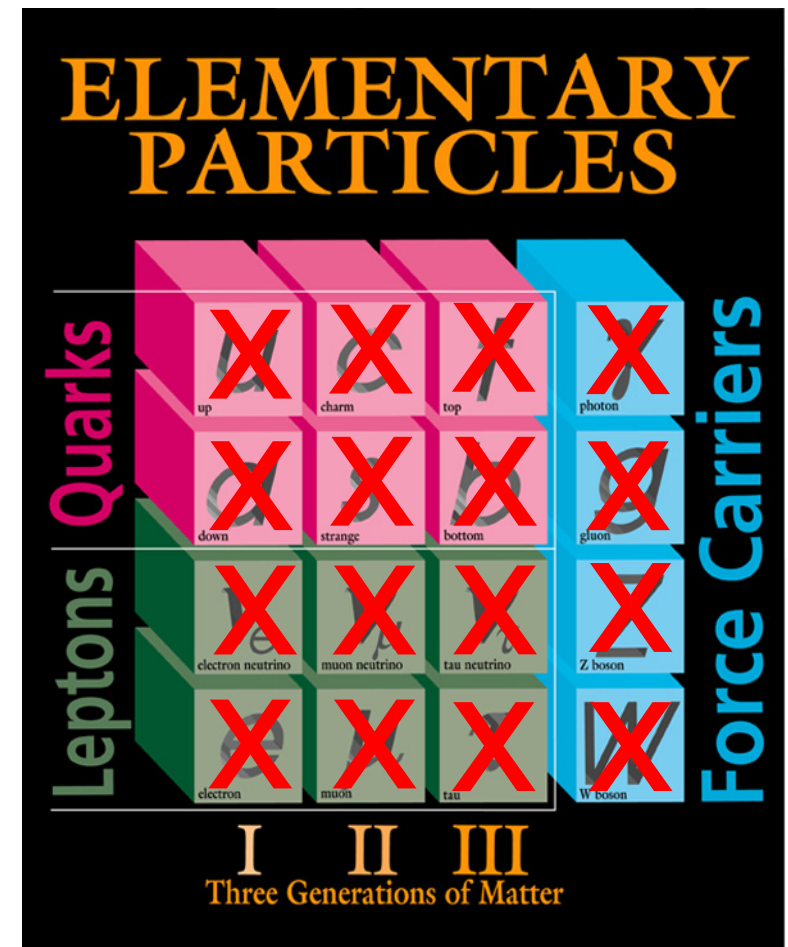

**This excludes all Standard Model particles:
*strong evidence for physics beyond the Standard Model!***

Dark Matter Candidates

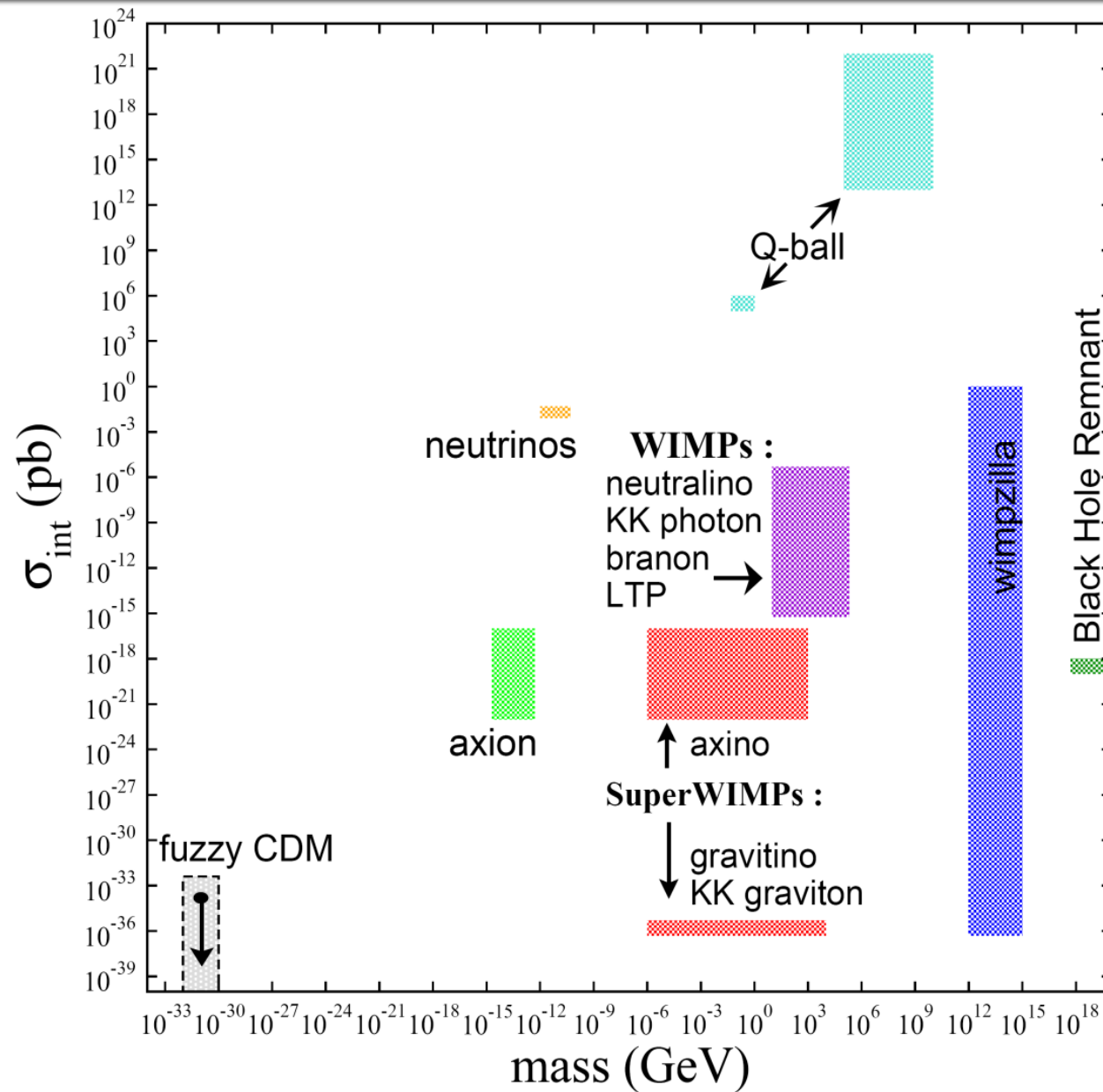

Thermal Relics

1) WIMPs are produced in thermal equilibrium

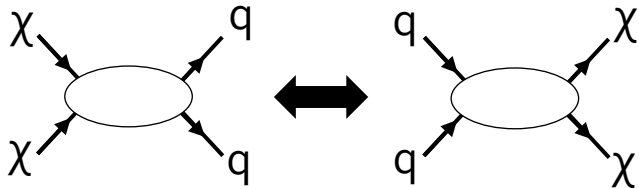

2) WIMP density decays as the universe cools

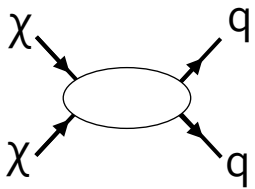

3) WIMP density "freezes out" based on coupling strength

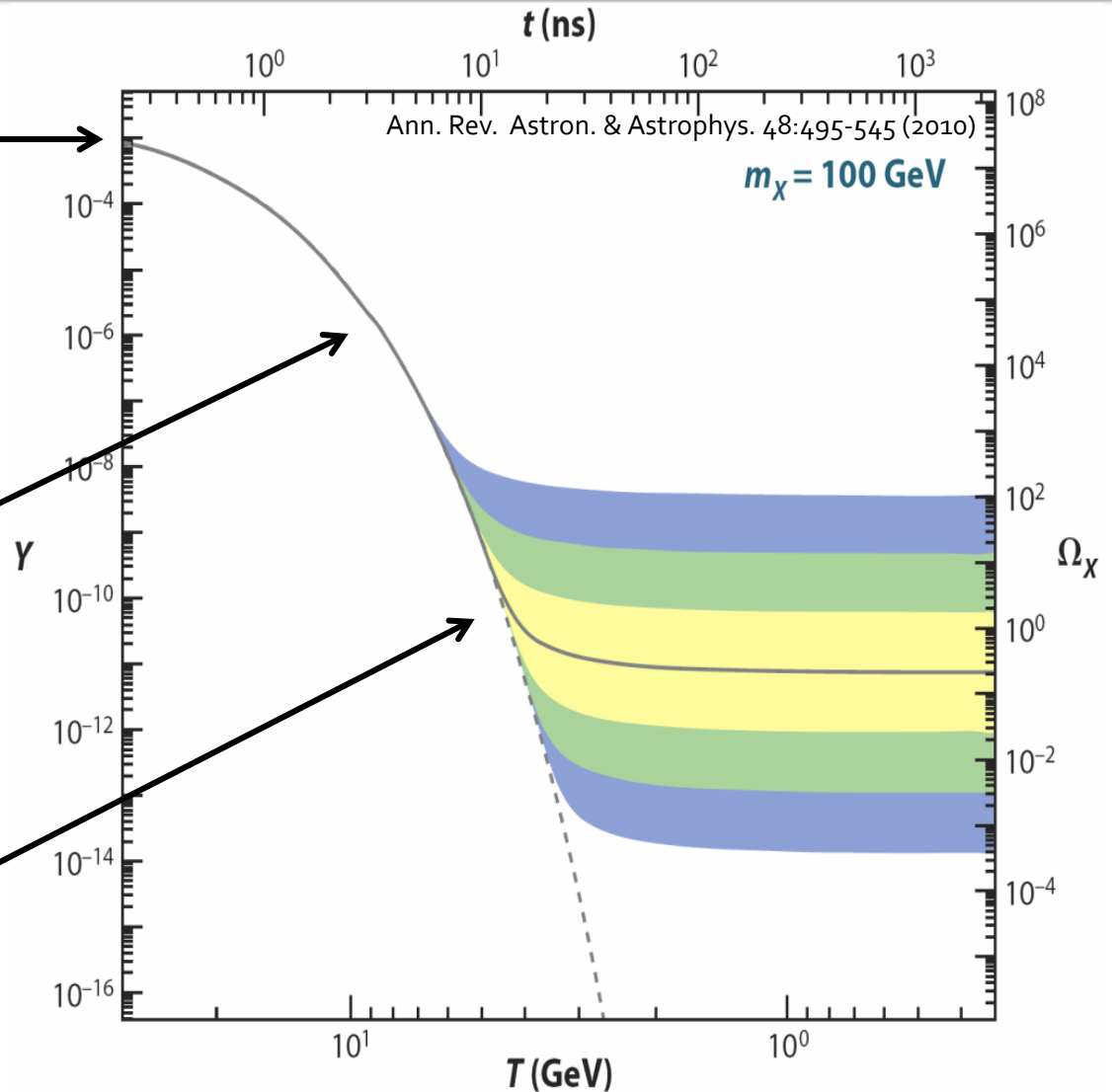
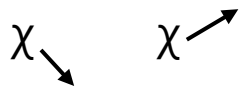

The "WIMP Miracle"

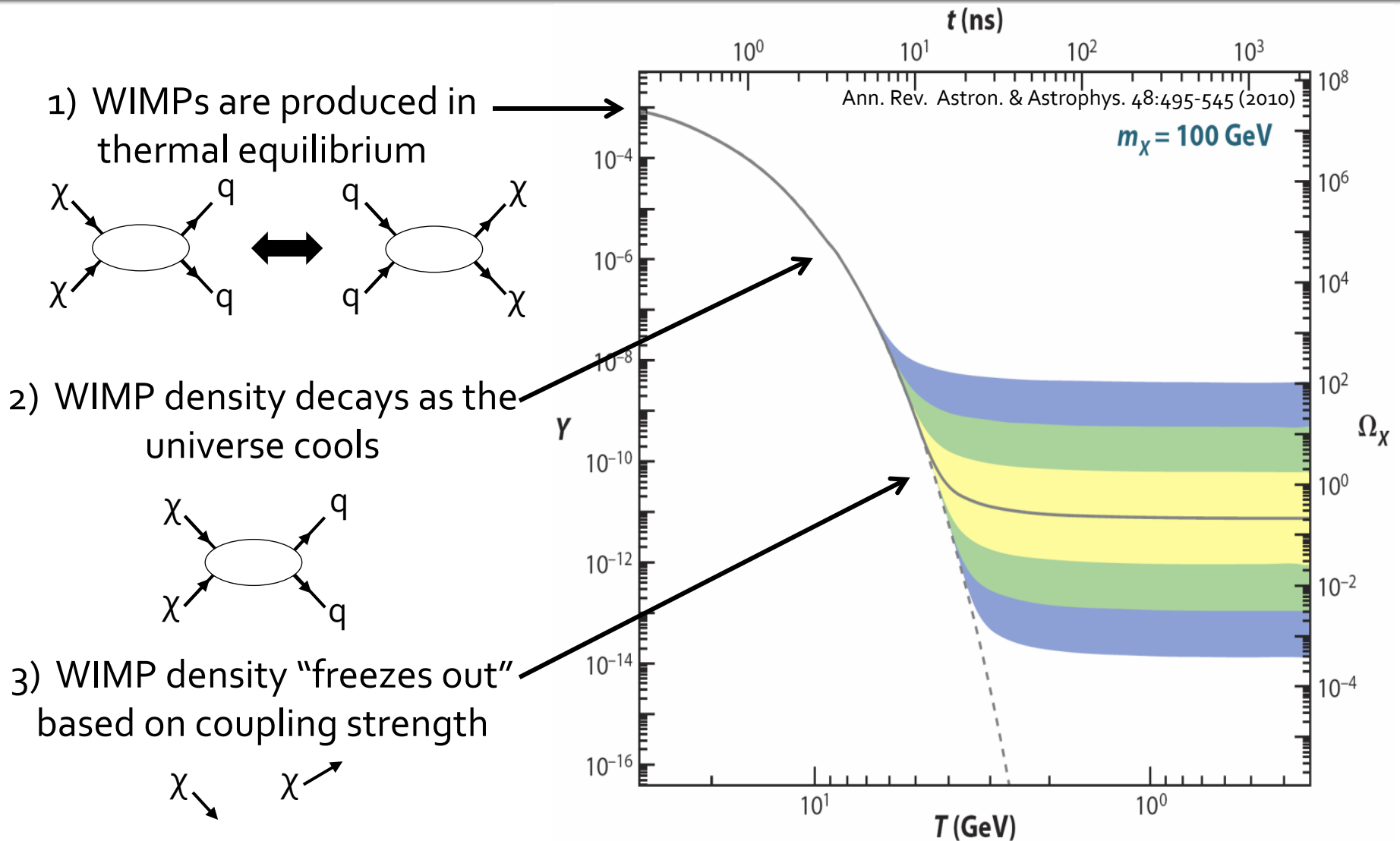

Weak mass & coupling give just the right relic density for dark matter!

Searching for WIMPs

Aboveground

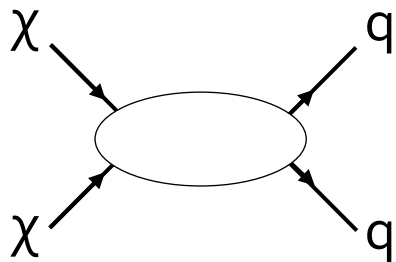
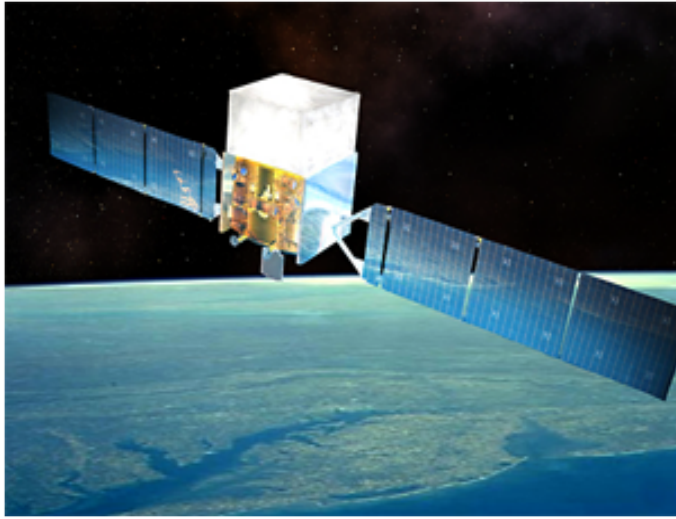

Underground

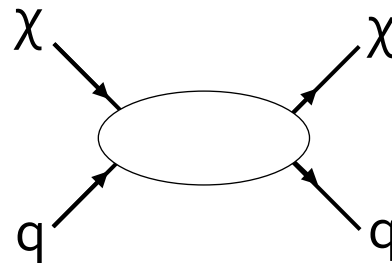

At Accelerators

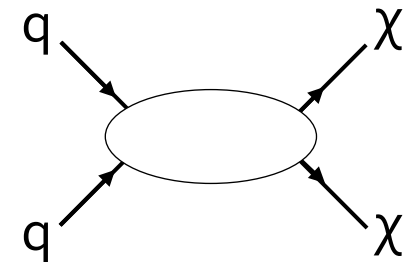
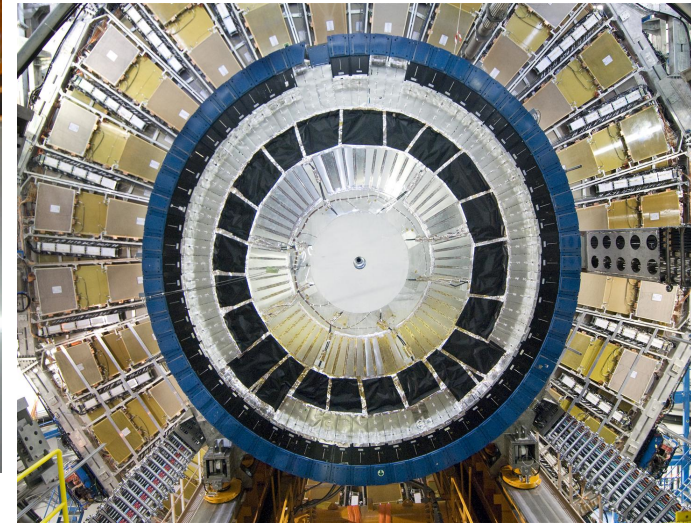

Local Dark Matter

- Galaxy embedded in a dark matter “halo”
- Local density $\approx 0.3 \text{ GeV}/c^2/\text{cm}^3$
- Independent galactic orbits
 - Typical $v_{\text{orbit}} \approx 220 \text{ km/s}$

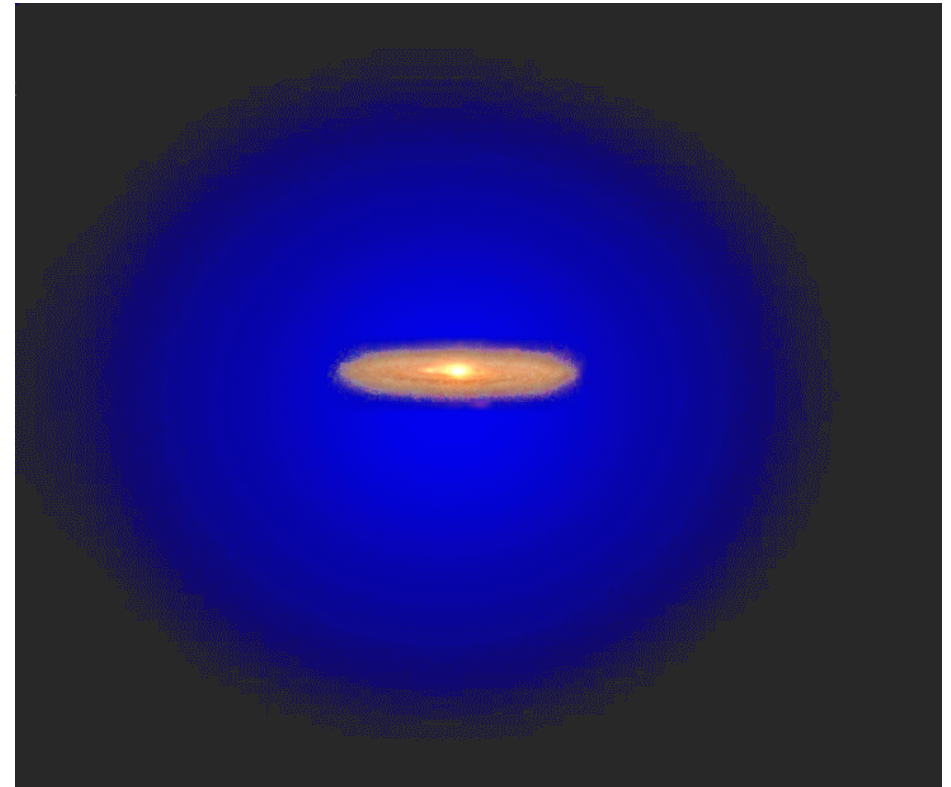

WIMP "Wind"

- Motion of the sun around the galaxy induces a WIMP "wind"
- Rotation of the earth about the sun produces a seasonal modulation in the velocity of the wind

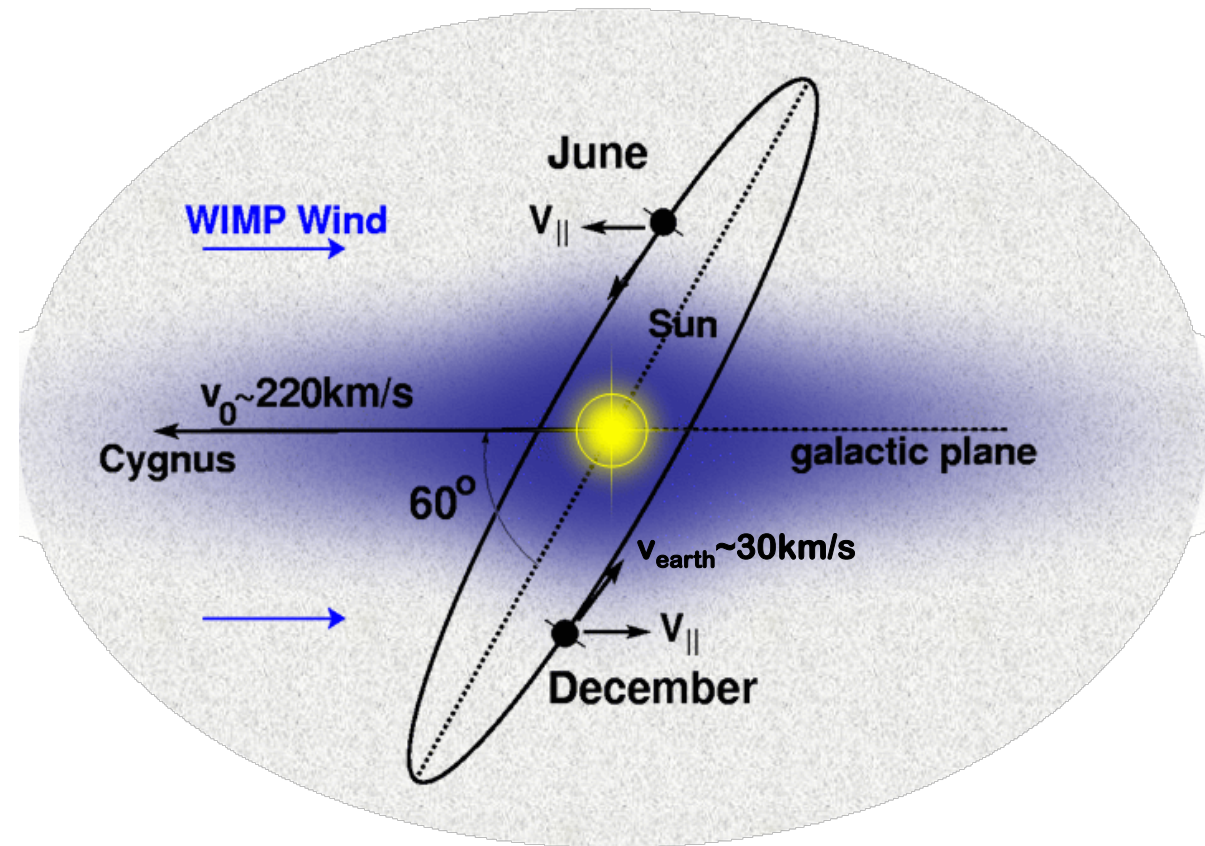

WIMP Direct Detection

- WIMPs scatter elastically from nuclei, inducing low energy nuclear recoils
 - $< \sim 100$ keV
- Cross section of $10^{-44} - 10^{-45}$ cm² *per nucleon* for “standard” WIMP
 - ~ 10 -100 interactions/tonne/yr

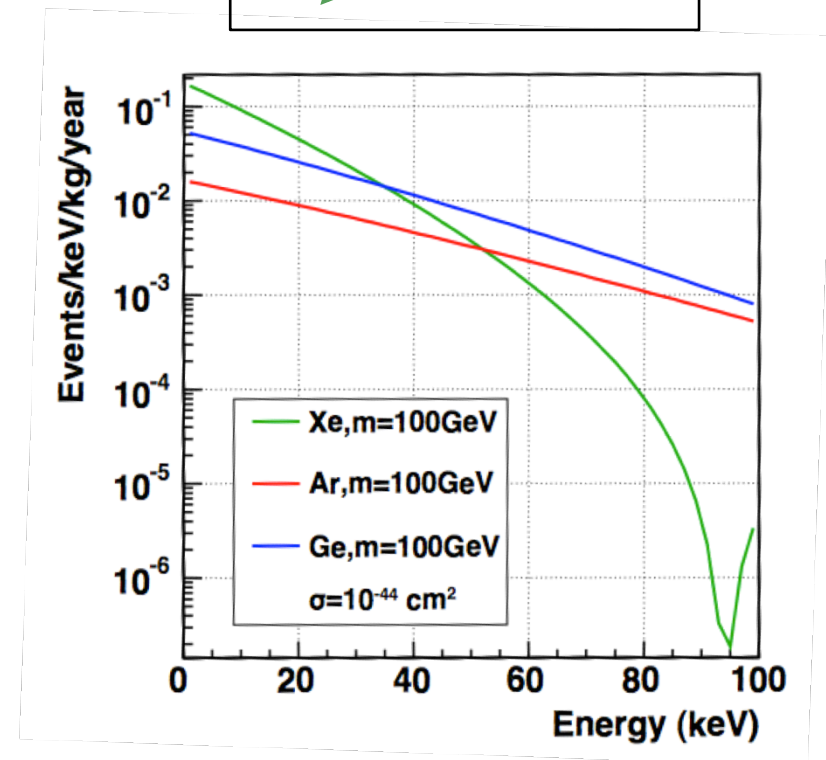
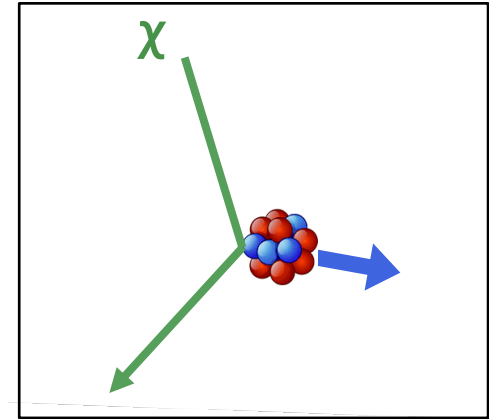

Central Challenge: Background

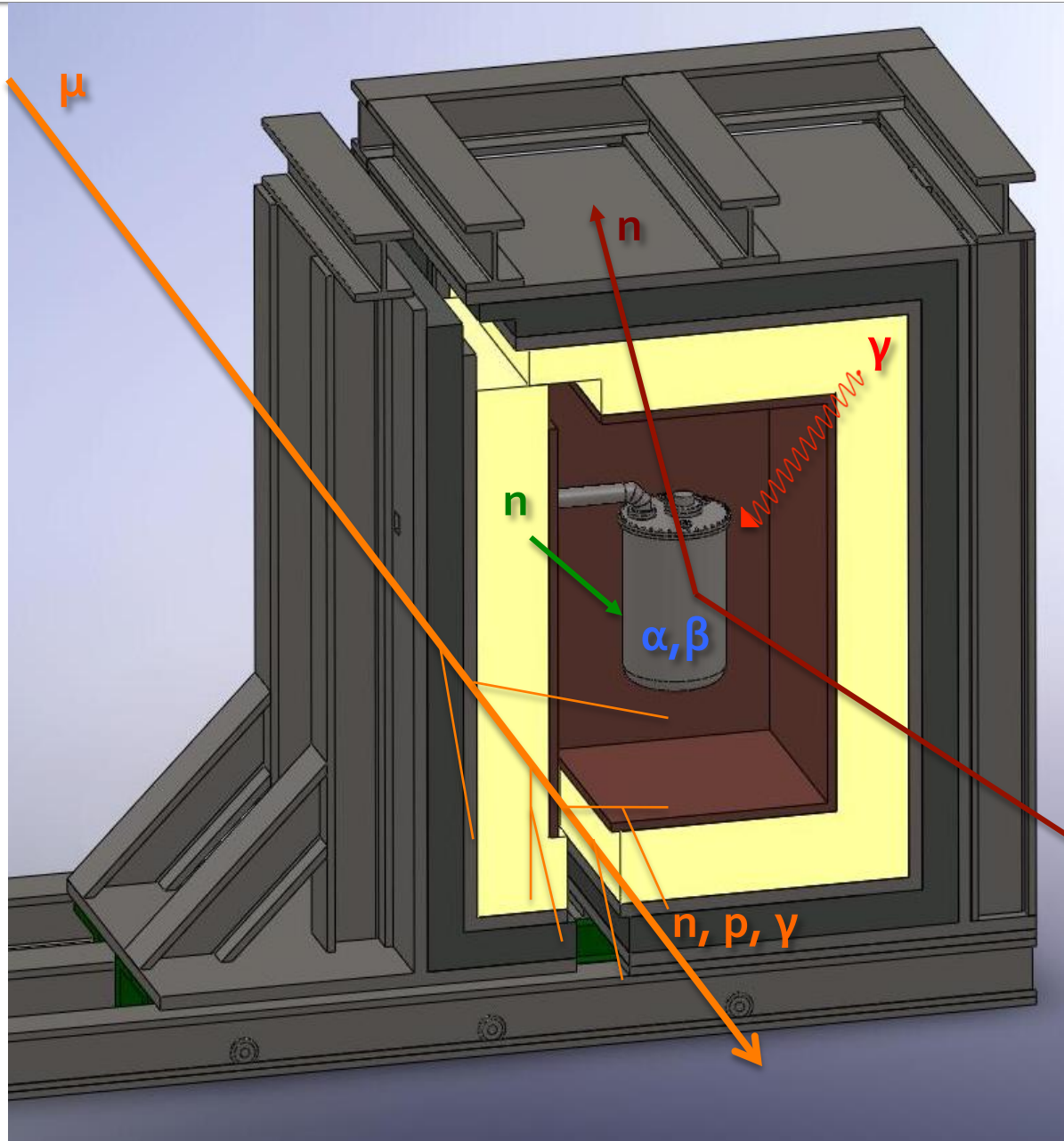

Internal Radioactivity

^{238}U , ^{232}Th , etc.

Gamma Rays

external and from shielding

Cosmic Muons

Radiogenic Neutrons

from spontaneous fission and (α, n) , externally and in shielding

Fast Neutrons

from muons in the shield and beyond

Central Challenge: Background

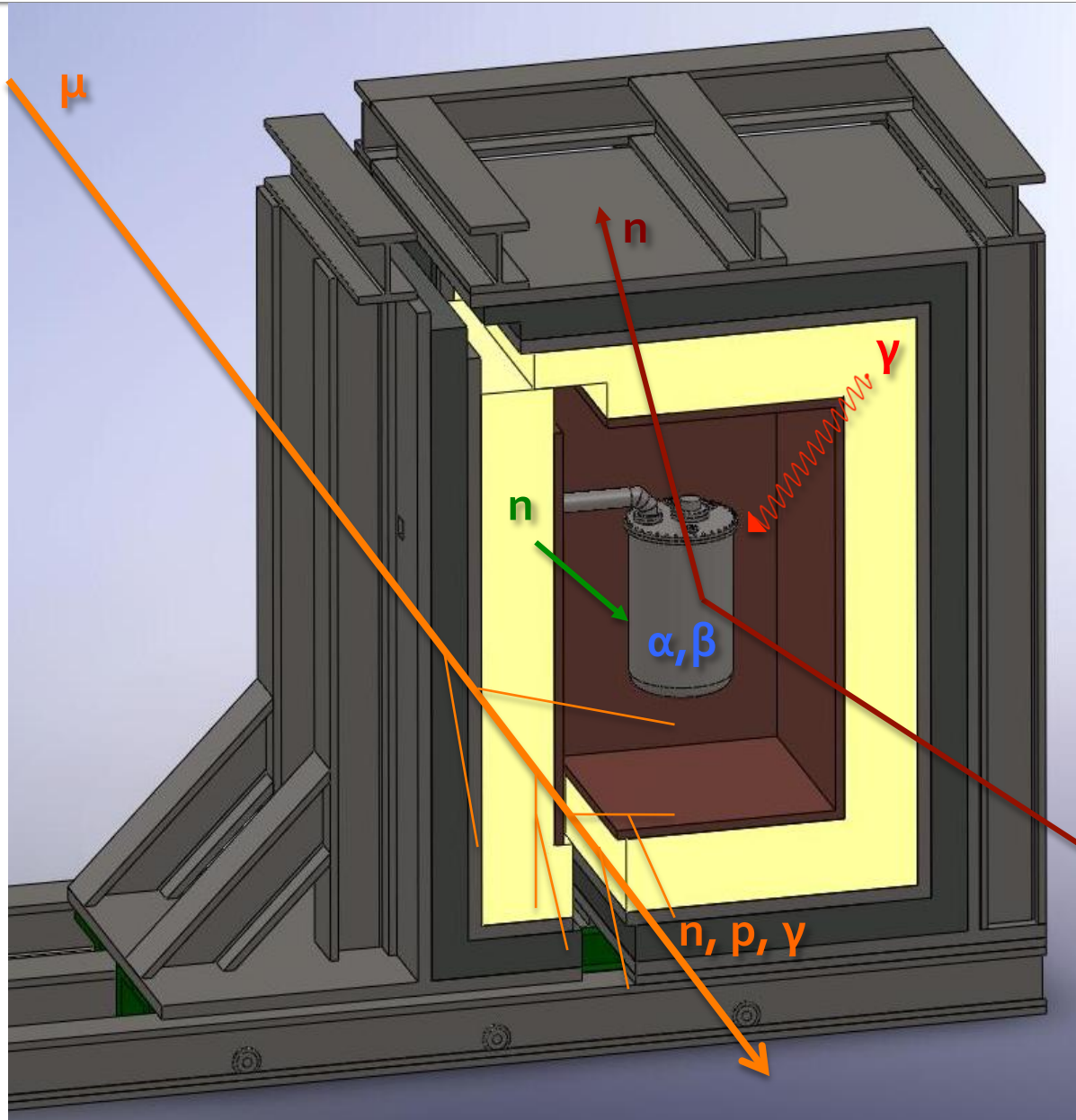

WIMP signal: < 100 ev/T-yr
Dust: ~ 7000 decays/mg-yr
Air: > 300 decays/mL-yr
Fingerprint: ~ 10 decays/yr

Ideal WIMP Detector

- Large mass, long exposure
- Low threshold
- Low background
- Background discrimination

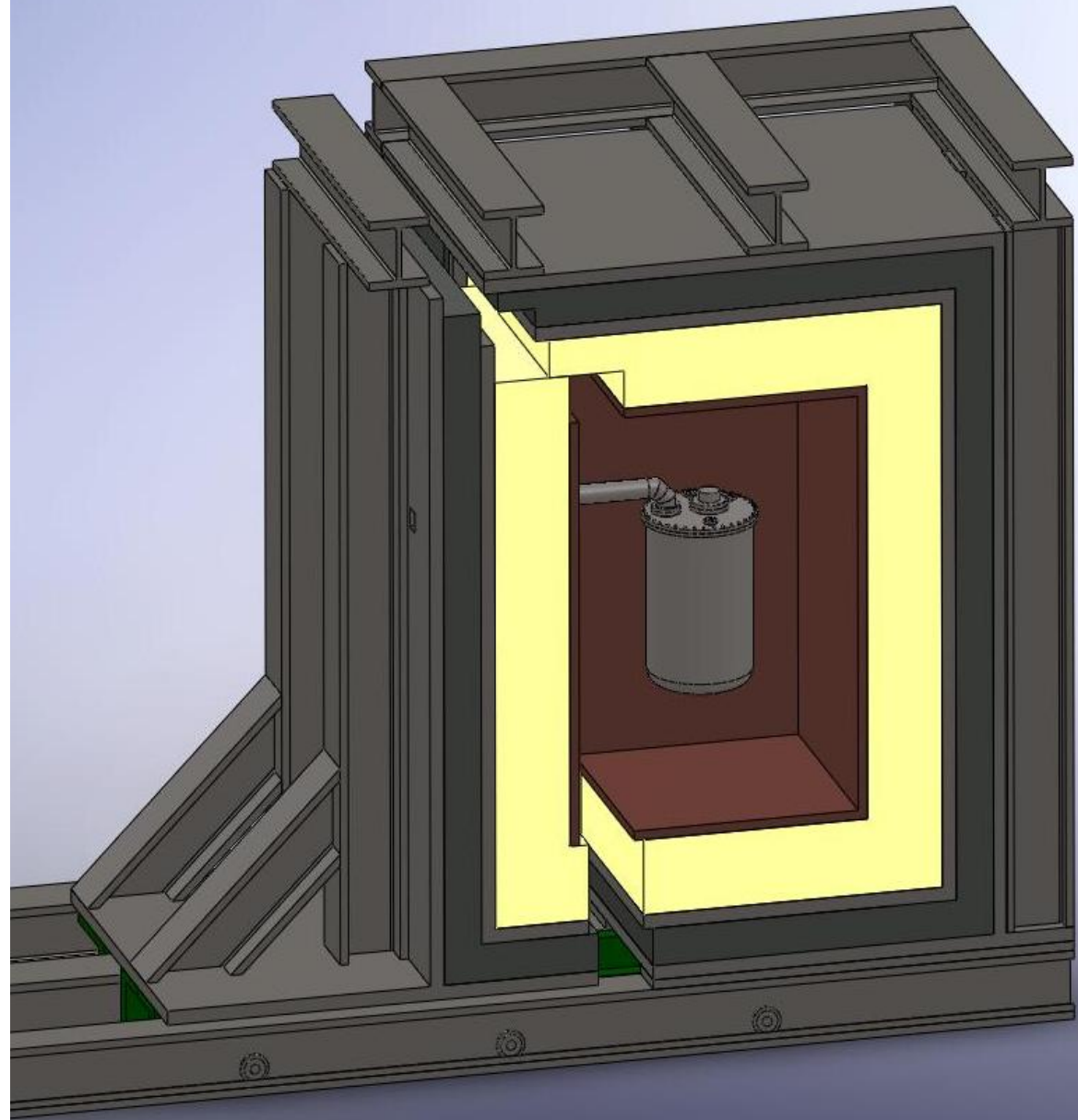

WIMP Detection Experiments

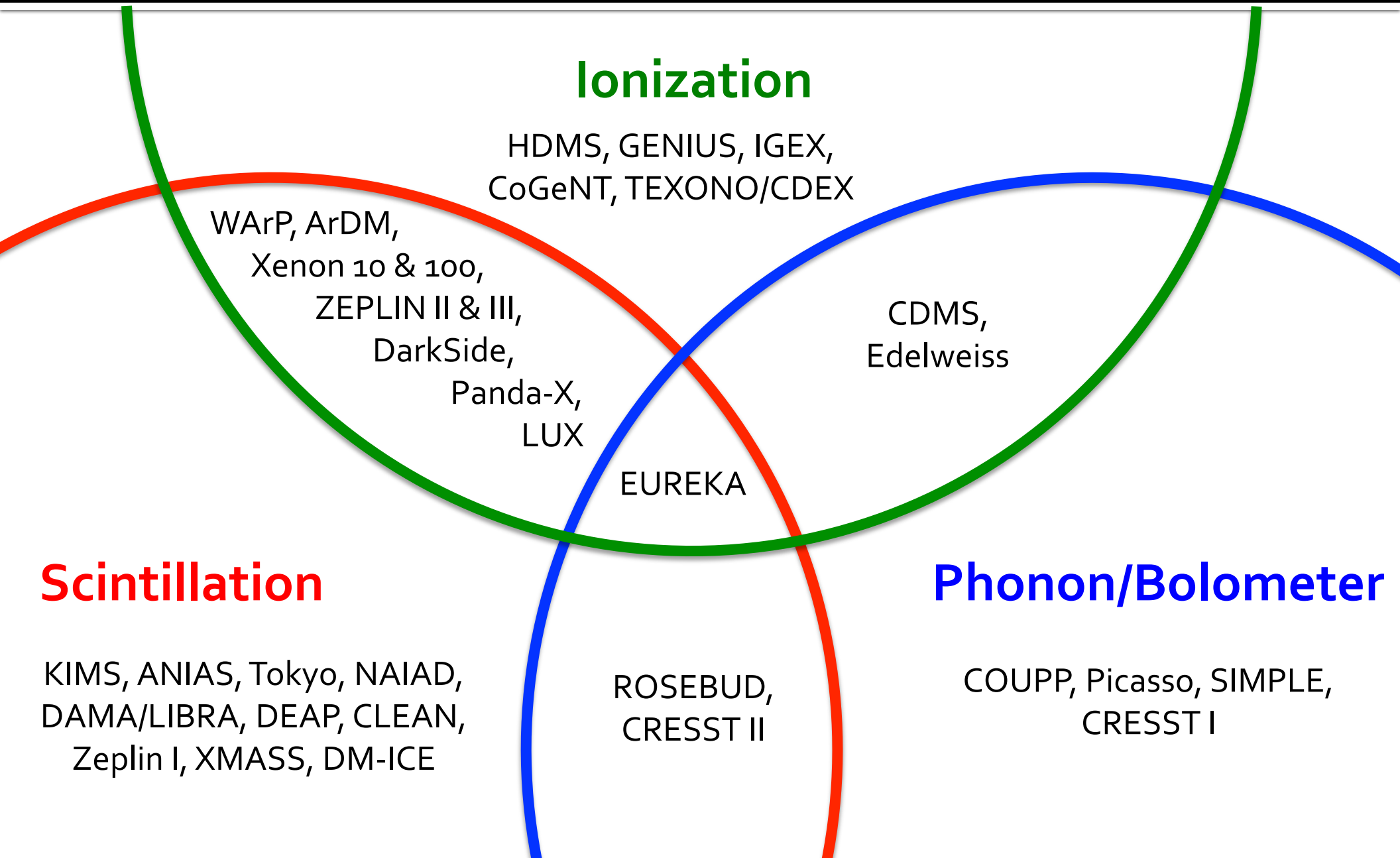

Ionization

HDMS, GENIUS, IGEX,
CoGeNT, TEXONO/CDEX

WArP, ArDM,
Xenon 10 & 100,
ZEPLIN II & III,
DarkSide,
Panda-X,
LUX

CDMS,
Edelweiss

EUREKA

Scintillation

KIMS, ANIAS, Tokyo, NAIAD,
DAMA/LIBRA, DEAP, CLEAN,
Zeplin I, XMASS, DM-ICE

Phonon/Bolometer

COUPP, Picasso, SIMPLE,
CRESST I

ROSEBUD,
CRESST II

Leading Experiments

Xenon100

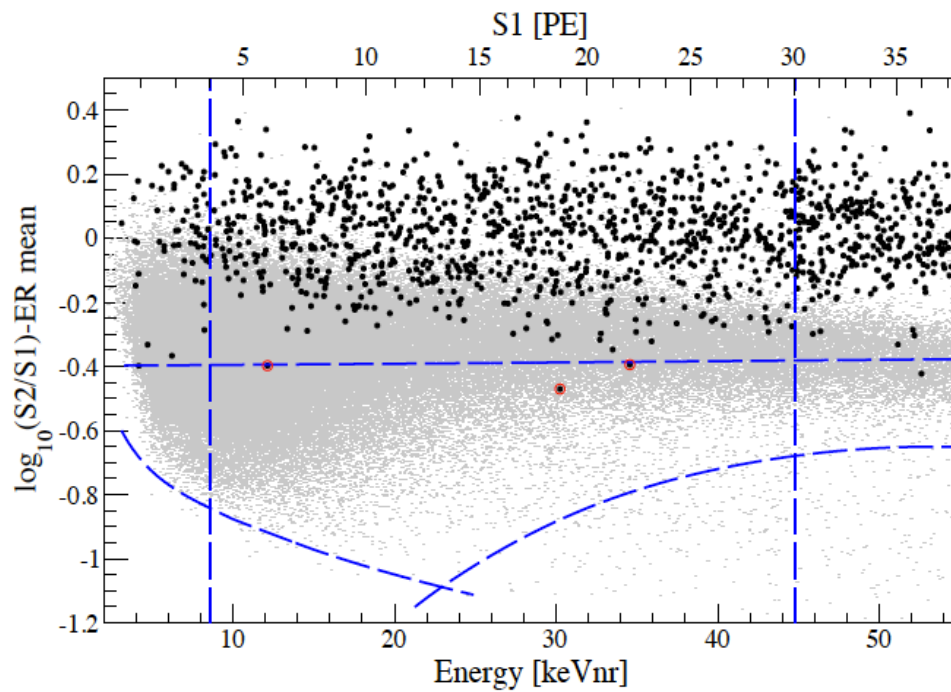

Technique: Xe,
scintillation + ionization
Exposure: 1471 kg-days
Expect: 1.8 ± 0.6 background events
Observe: 3 events

PRL 107:131302 (2011)

CDMS

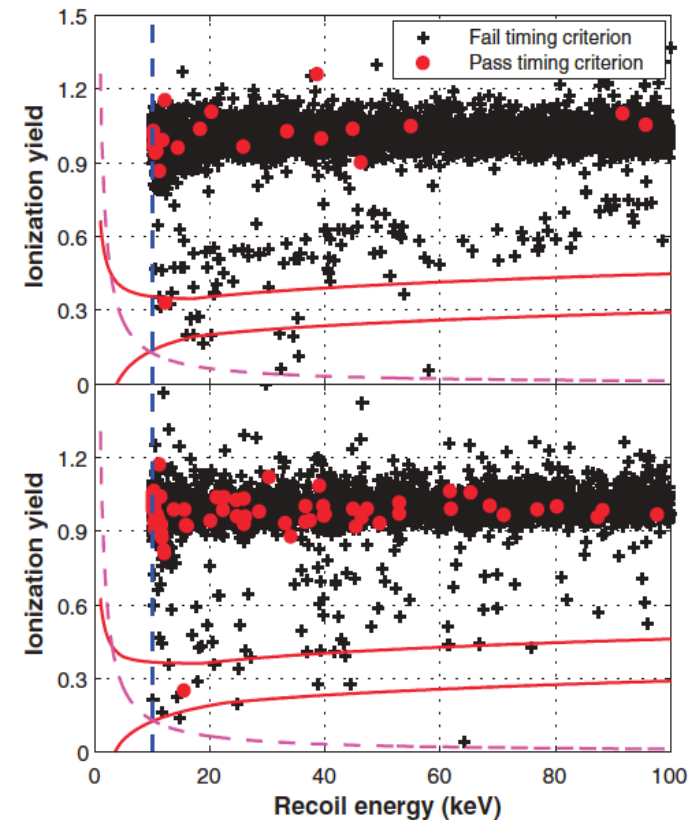

Technique: Ge + Si,
ionization + bolometric
Exposure: 612 kg-days
Expect: 0.9 ± 0.2 background events
Observe: 2 events

Nature 327:1619 (2010)

Leading Experiments

Edelweiss

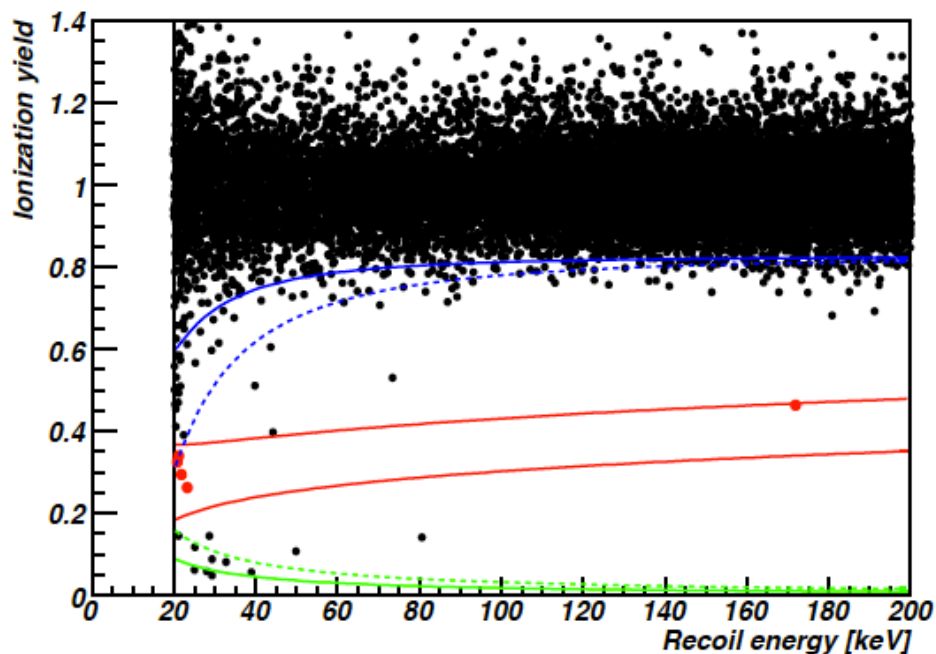

Technique: Ge,
ionization + bolometric
Exposure: 384 kg-days
Expect: <3 background events
Observe: 5 events

Cresst

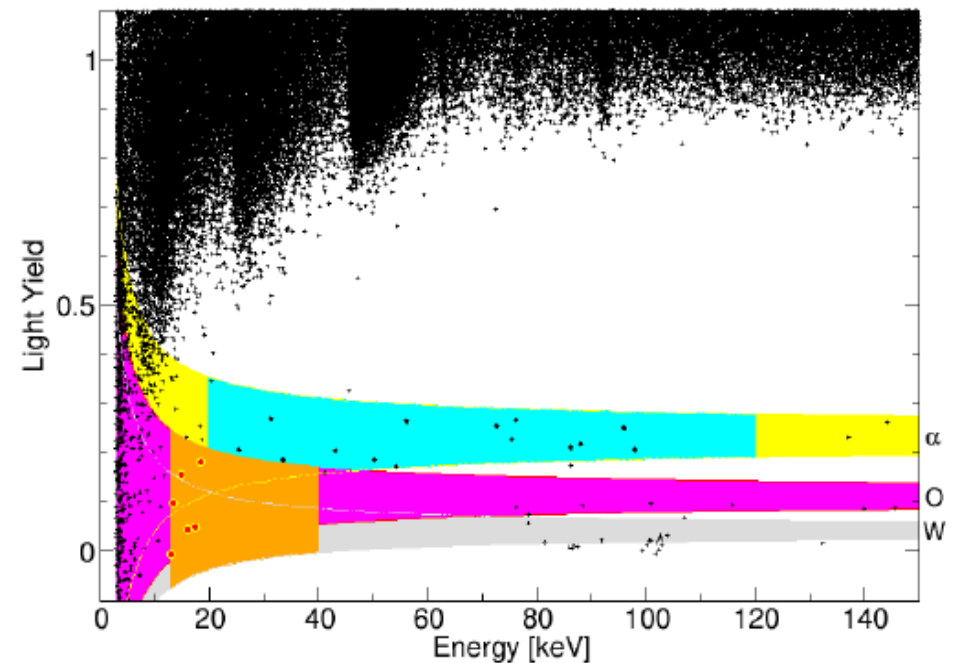

Technique: CaWO_4
scintillation + bolometric
Exposure: 730 kg-days
Observe: $29.4^{+8.6}_{-7.7}$ ($24.2^{+8.1}_{-7.2}$) events
above background of 42-48 events

Leading Experiments

DAMA/LIBRA

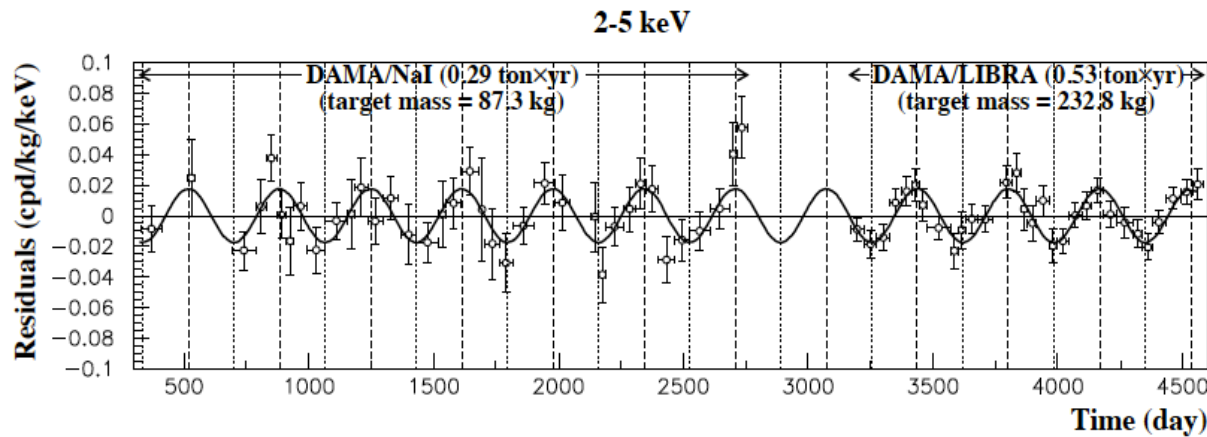

Technique: NaI, scintillation
Exposure: 4.3×10^5 kg-days
Observe: Annual modulation in event rate.

Eur. Phys. J. C 56:333-355 (2008)

CoGeNT

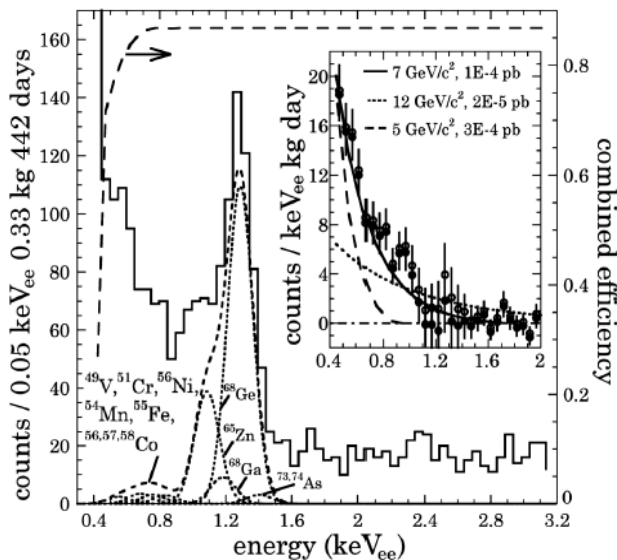

Technique: Ge, ionization
Exposure: 146 kg-days
Observe: Excess events at low energy, probably an annual modulation

PRL 106:131301 (2011),
 PRL 107:141301 (2011)

The Current Status

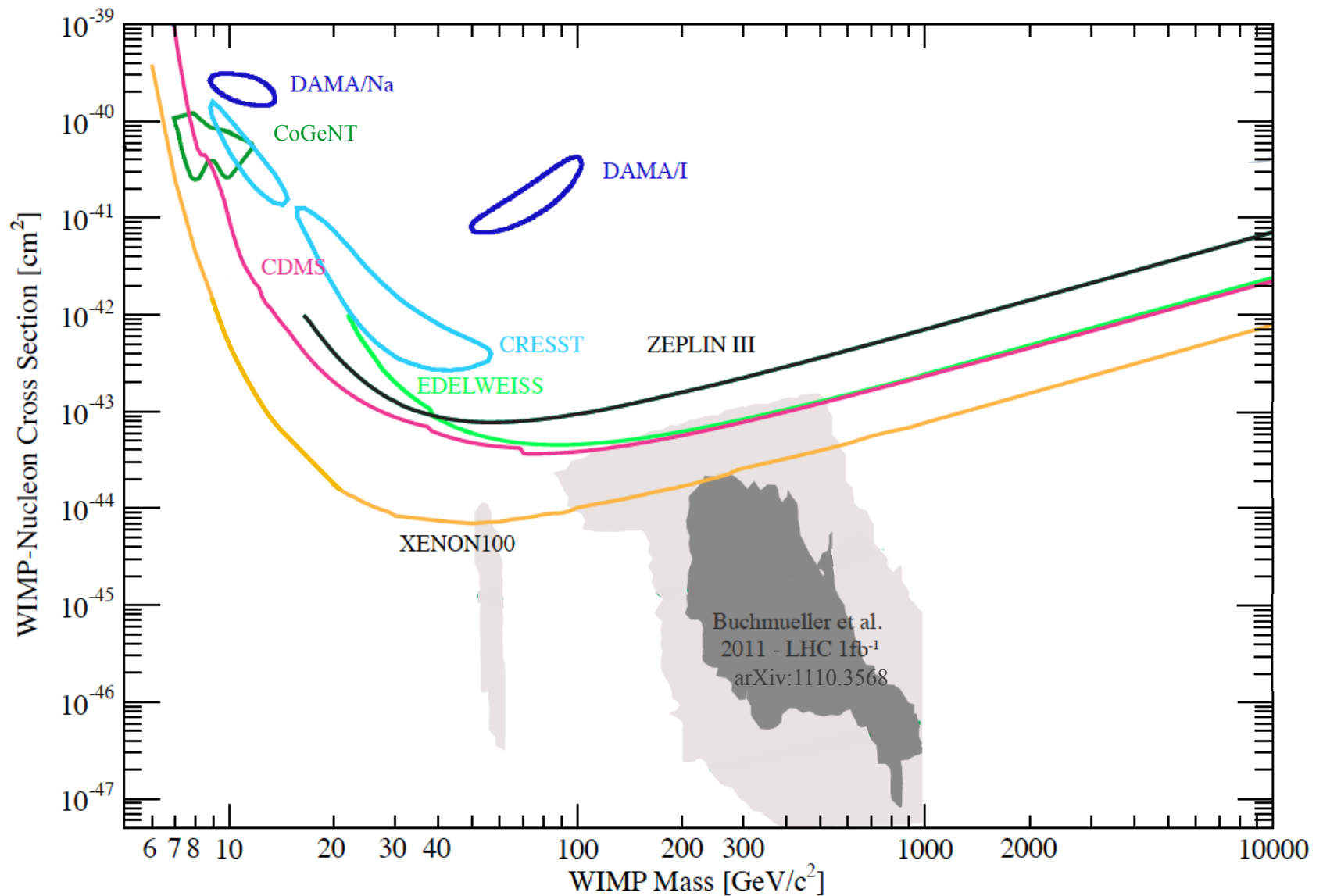

The Current Status

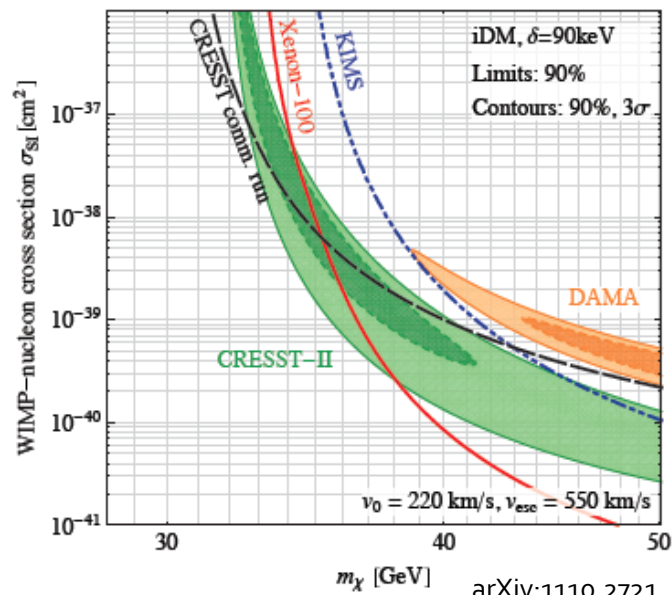
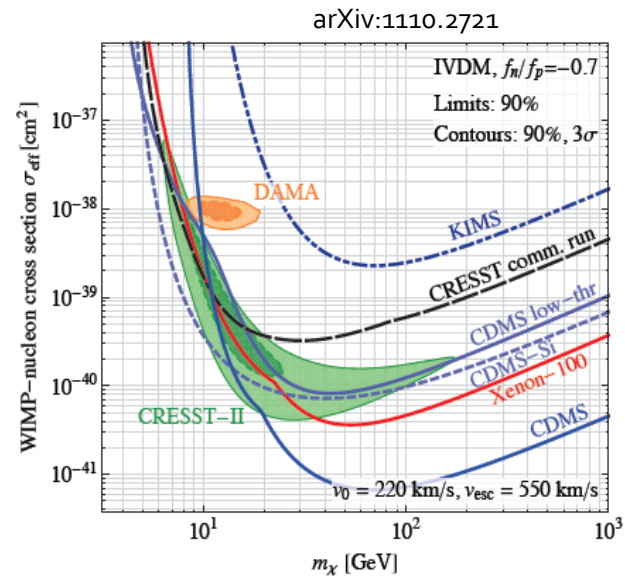
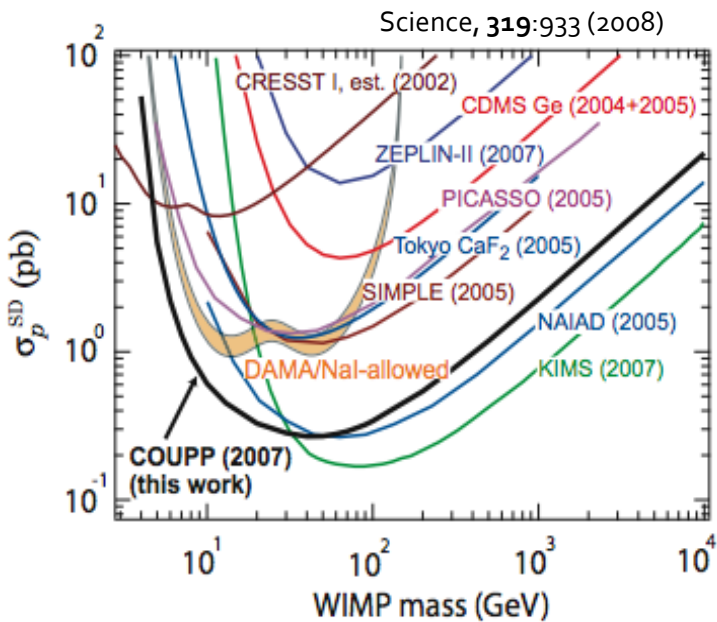

The Current Status

In dark matter searches, the trouble starts when you see something.

- All leading dark matter experiments expect background and they see it
- Progress contingent on achieving lower, better controlled backgrounds

DarkSide

- A dark matter program based on 2-phase underground argon time projection chambers (TPCs)
- First physics detector will be “DarkSide-50”

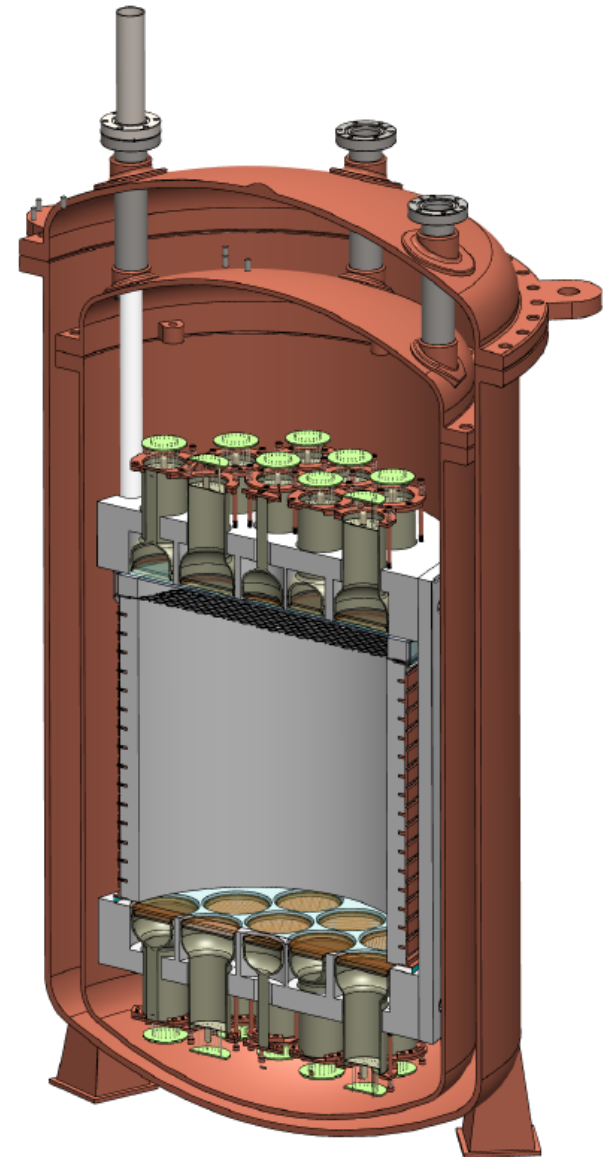





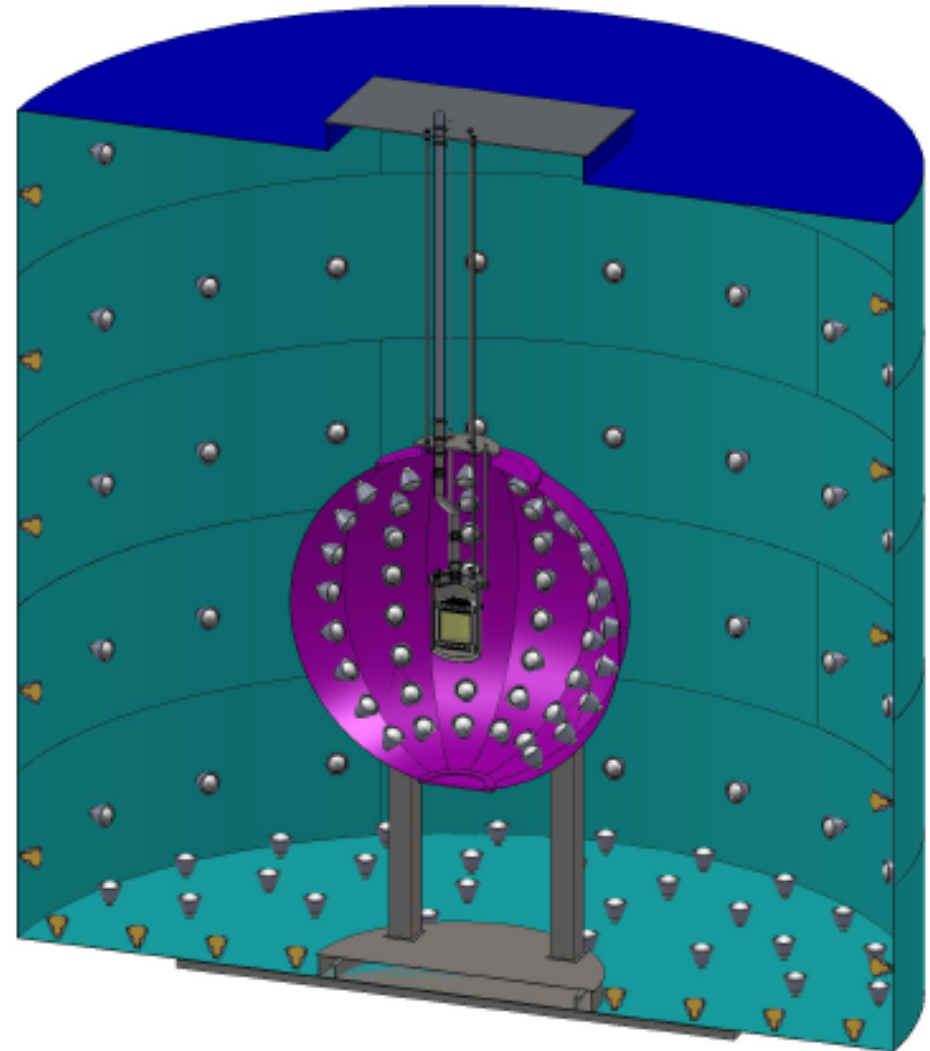



DarkSide Background Strategy

- Designed to have very low, very well understood background
- Underground argon and other novel technologies give very low background levels
- Further suppress backgrounds and assay them *in situ* using active background suppression techniques



Darkside Collaboration

- Augustana College – SD, USA 
- Black Hill State University – SD, USA 
- Fermilab – Il, USA 
- INFN Laboratori Nazionali del Gran Sasso – Assergi, Italy 
- INFN and Università degli Studi Genova, Italy 
- INFN and Università degli Studi Milano, Italy 
- INFN and Università degli Studi Naples, Italy 
- INFN and Università degli Studi Perugia, Italy 
- Institute for High Energy Physics – Beijing, China 
- Joint Institute for Nuclear Research – Dubna, Russia 
- Lomonosov Moscow State University, Russia 
- Princeton University, USA 
- RRC Kurchatov Institute – Moscow, Russia 
- St. Petersburg Nuclear Physics Institute – Gatchina, Russia 
- Temple University – PA, USA 
- University of Arkansas, USA 
- University of California, Los Angeles, USA 
- University of Houston, USA 
- University of Massachusetts at Amherst, USA 
- Virginia Tech, USA 

Why Two-Phase Argon?

- Liquid argon is a great dark matter target
 - Good scintillator (~40,000 photons/MeV)
 - Very transparent to its own scintillation light
 - Easily purified
- Relatively inexpensive technology, could be scaled to multi-tonne detectors
 - Need to suppress ^{39}Ar
- Very powerful rejection capability for electron recoil background

2-Phase Argon TPC

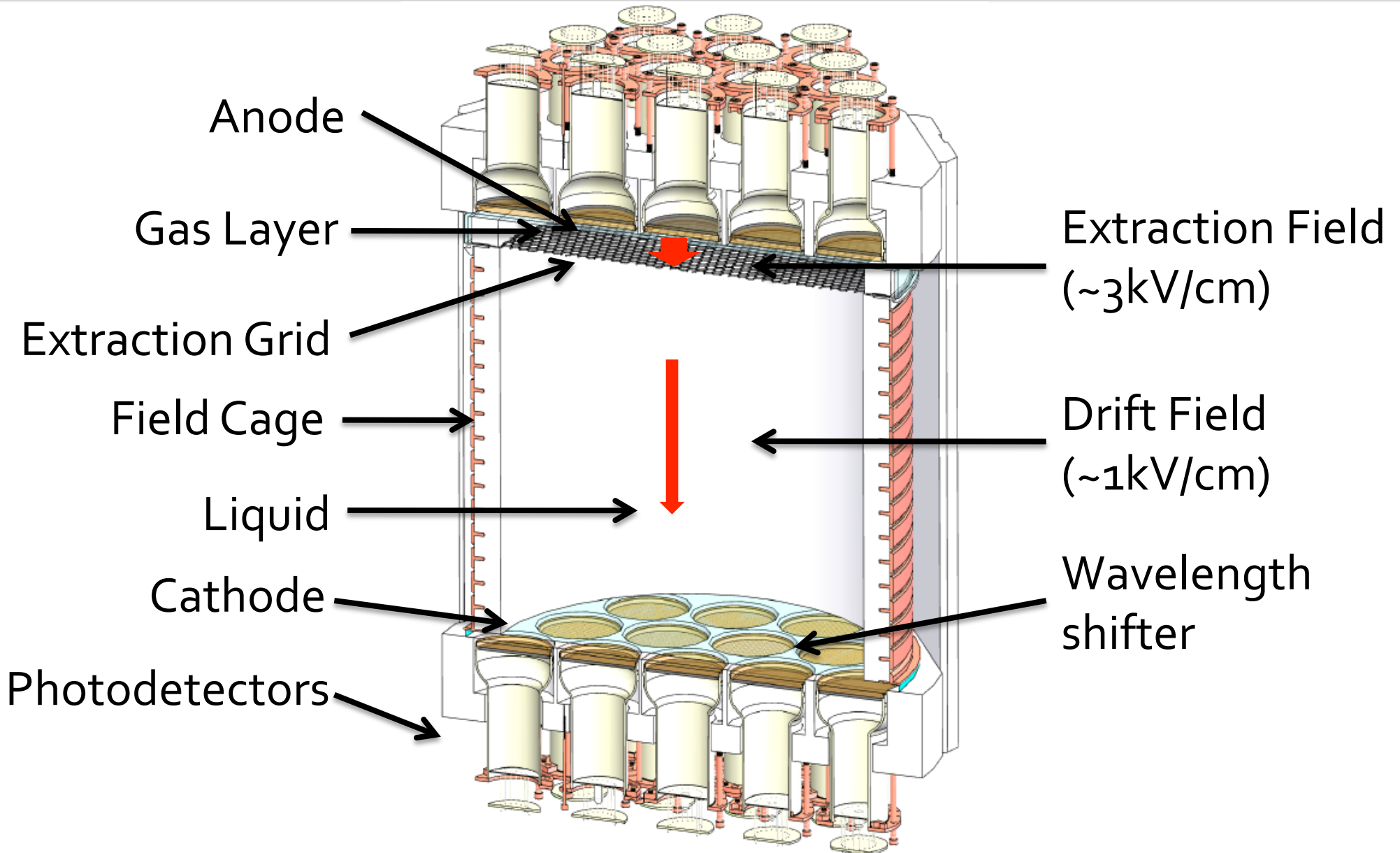

Two Phase Argon TPC

"S₁" Scintillation
Light

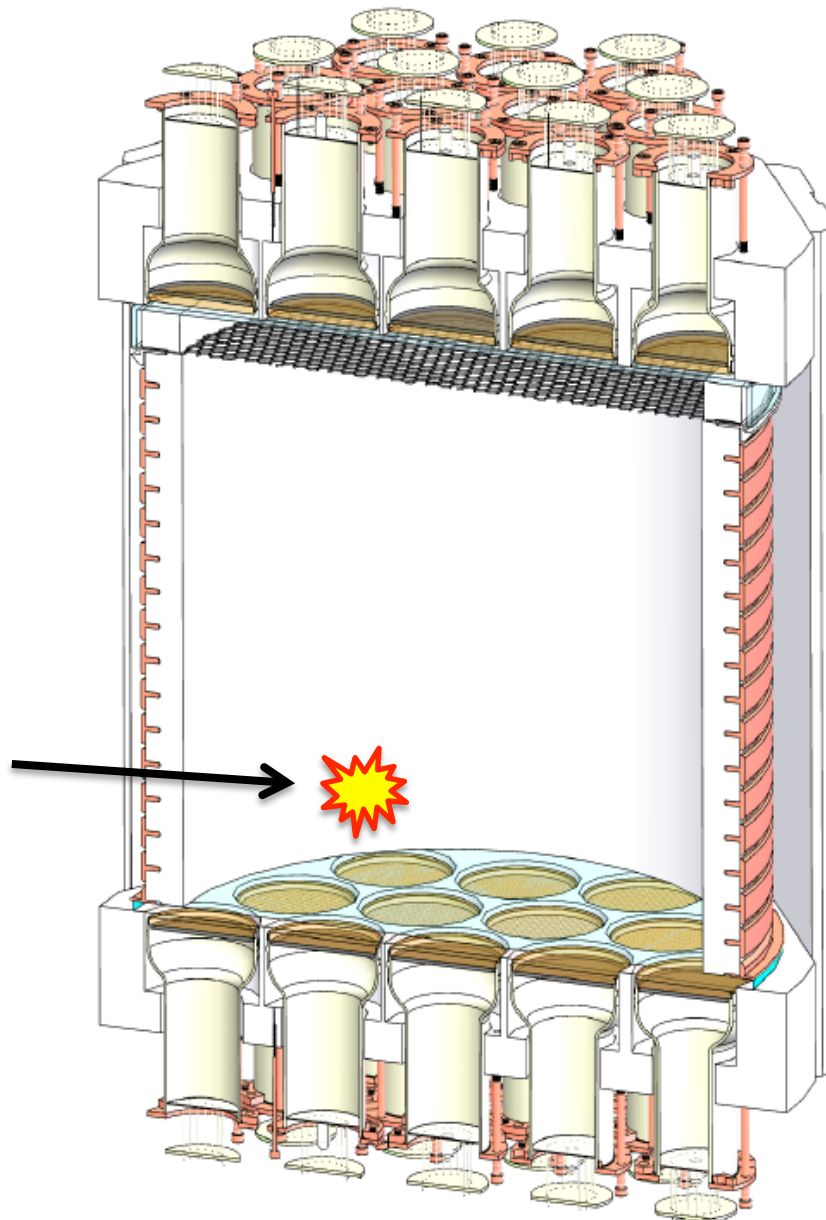

Two Phase Argon TPC

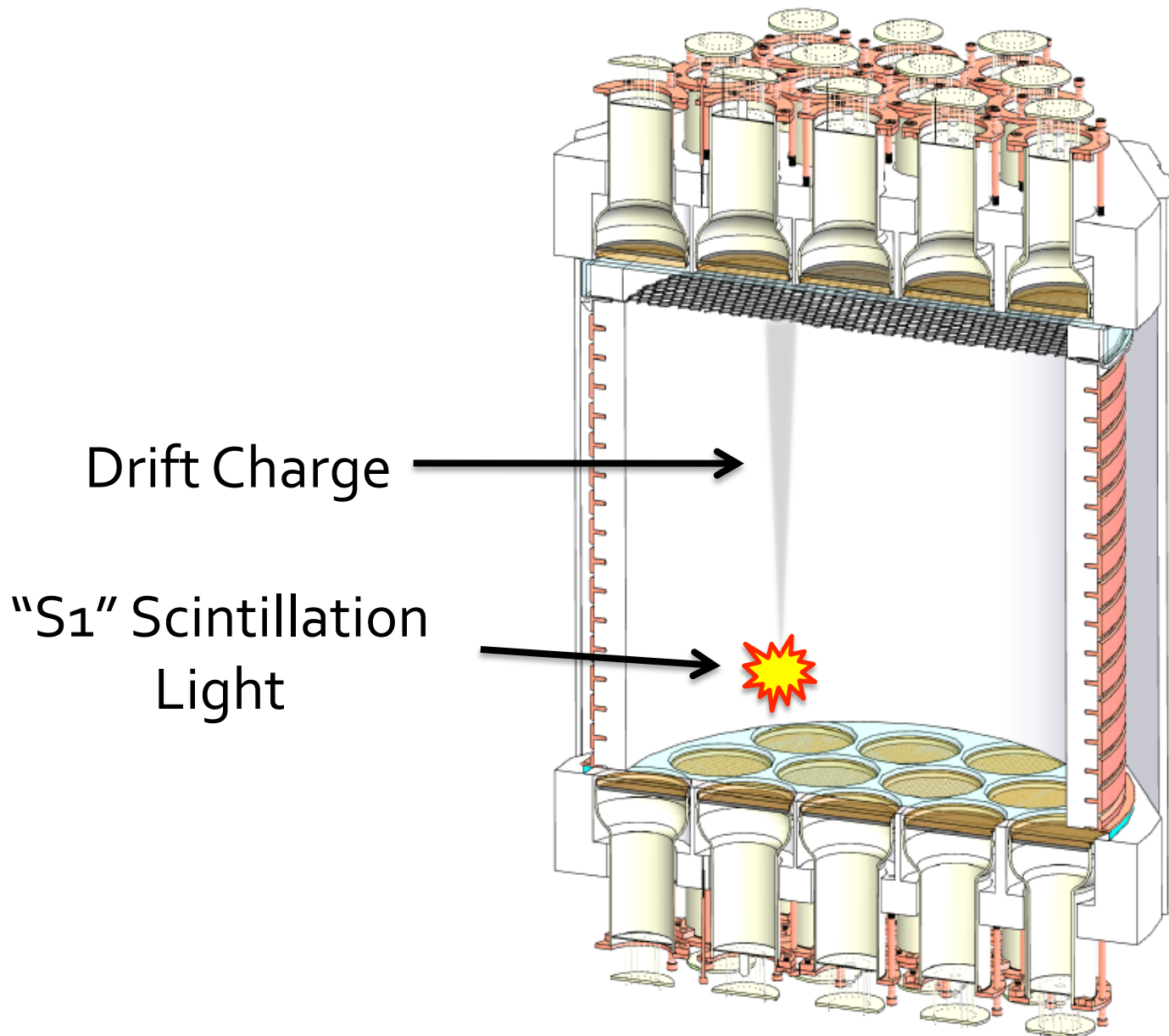

Two Phase Argon TPC

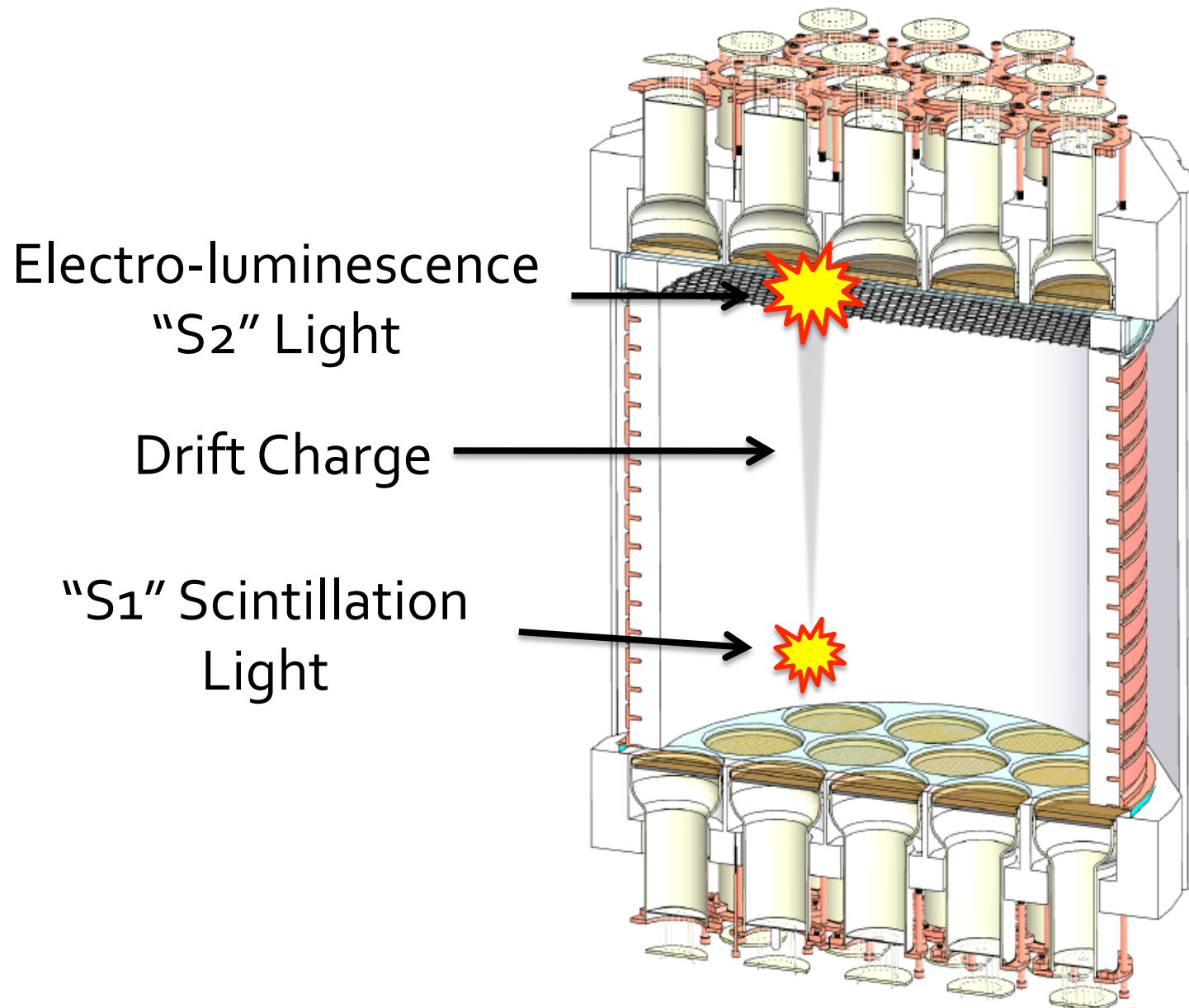

Two Phase Argon TPC

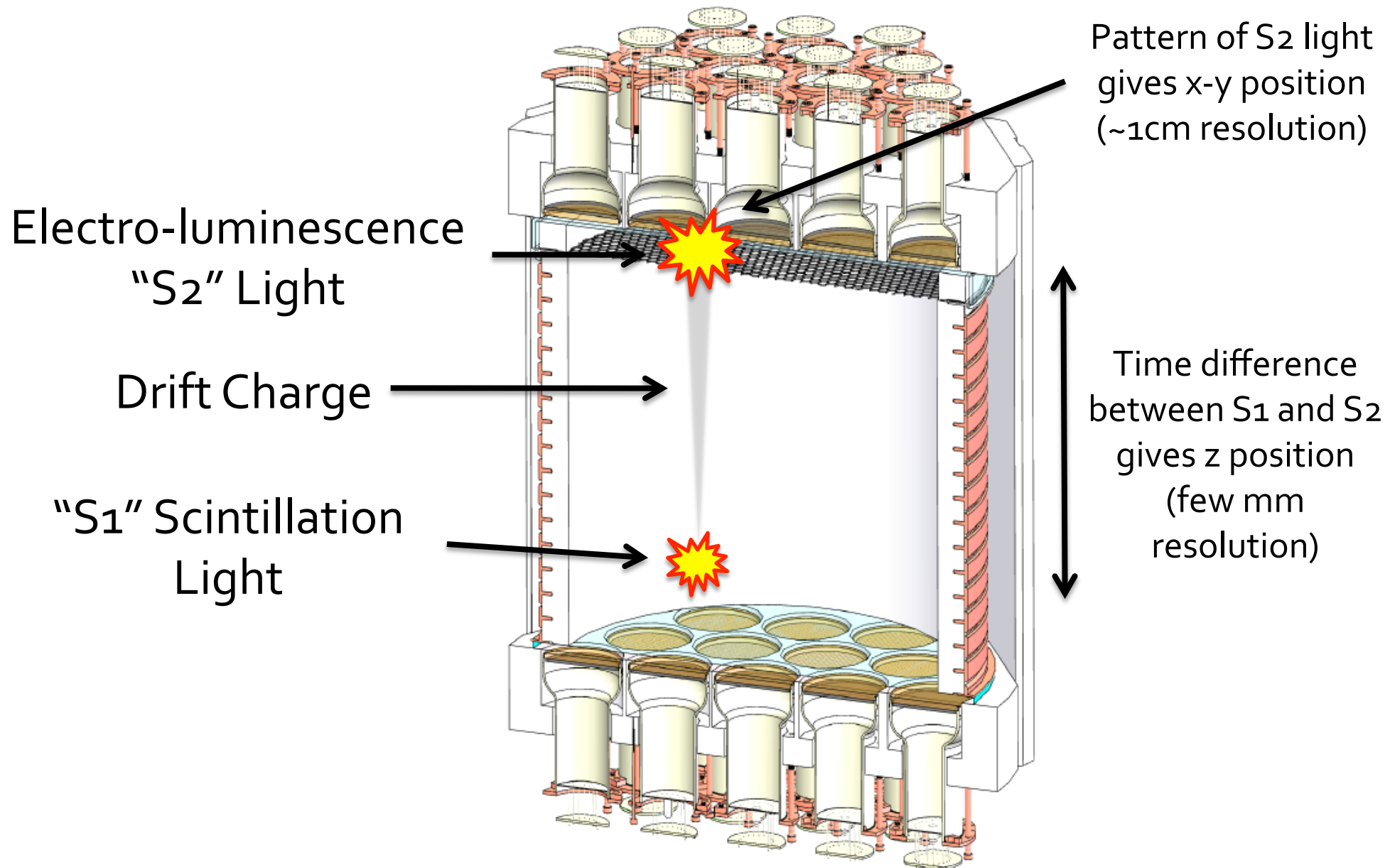

"S₁" Electron Recoil Discrimination

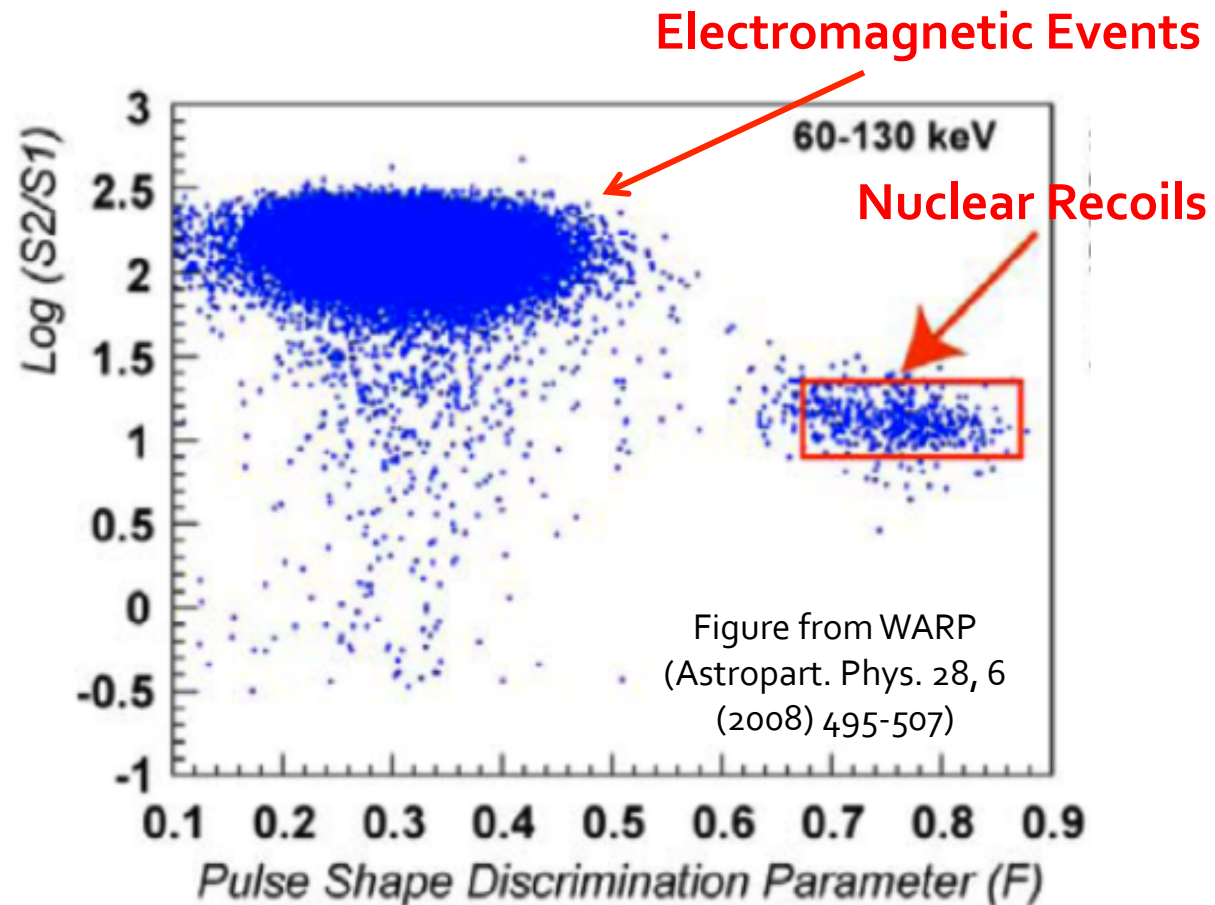
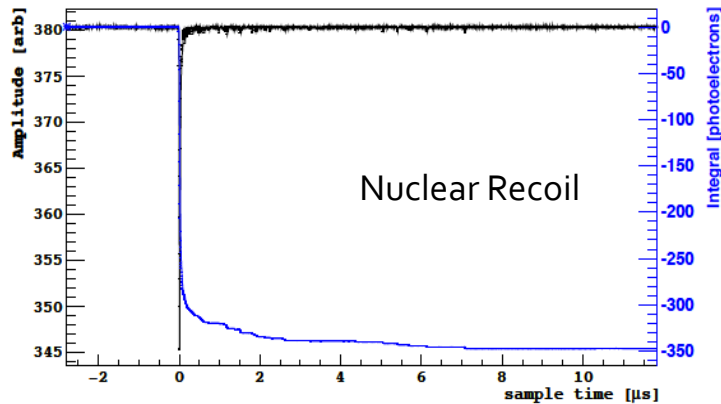
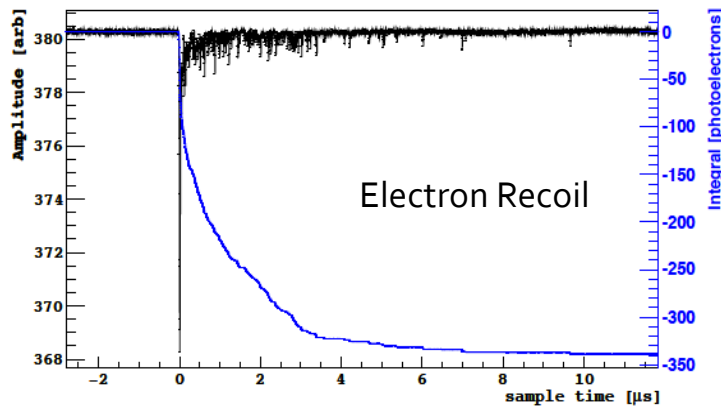

- The ratio of light from singlet (~7 ns decay time) and triplet (1.6 μs decay time) depends on ionization density
 ➔ $>10^8$ discrimination from pulse shape

"S₂/S₁" Electron Recoil Discrimination

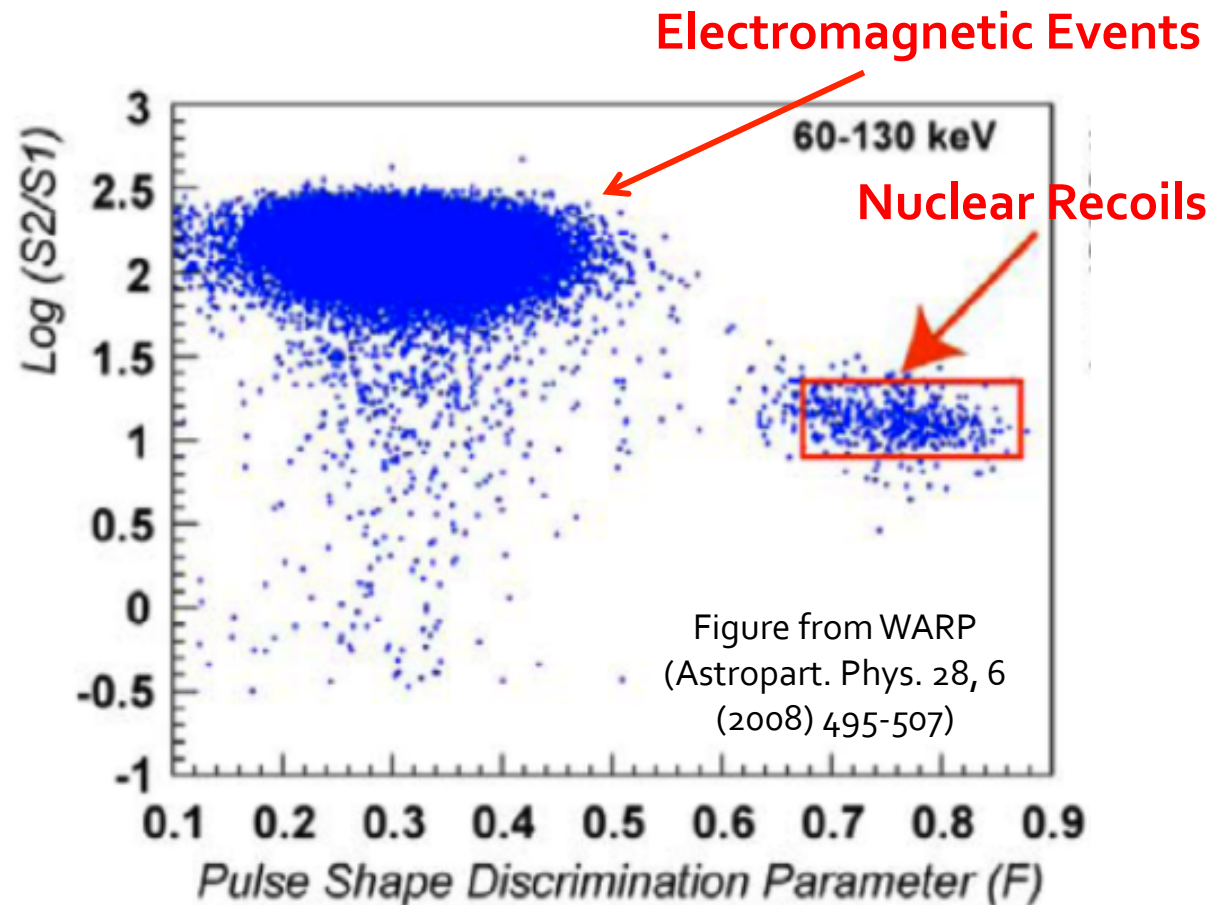
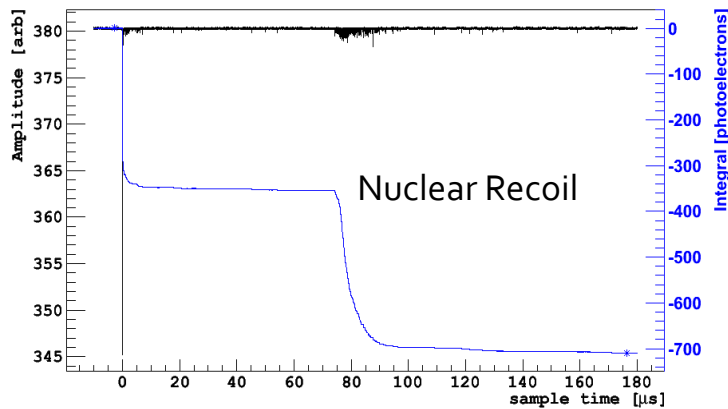
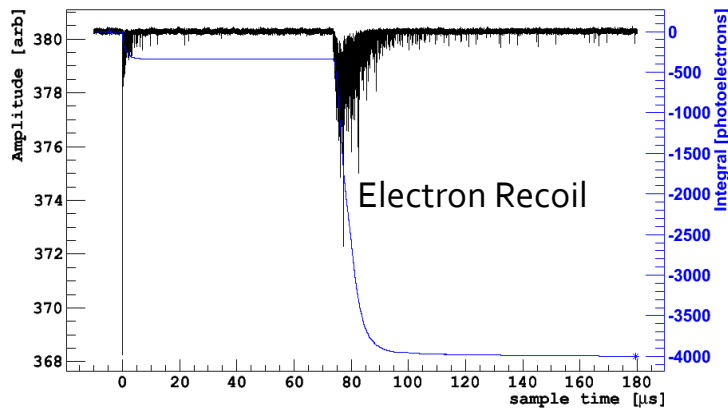

- The recombination probability (and hence the ratio of S₂:S₁ light) also depends on ionization density
 - 10^2 - 10^3 additional discrimination
 - $>10^{10}$ total electron recoil rejection in 2D

^{39}Ar

- Radioactive, β -decay, $T_{1/2} = 269$ years
- Cosmogenic
 - $^{40}\text{Ar}(n,2n)^{39}\text{Ar}$ in the atmosphere
- ~ 1 Bq/kg in atmospheric argon
 - 3×10^{10} events in 1.0 ton-year!

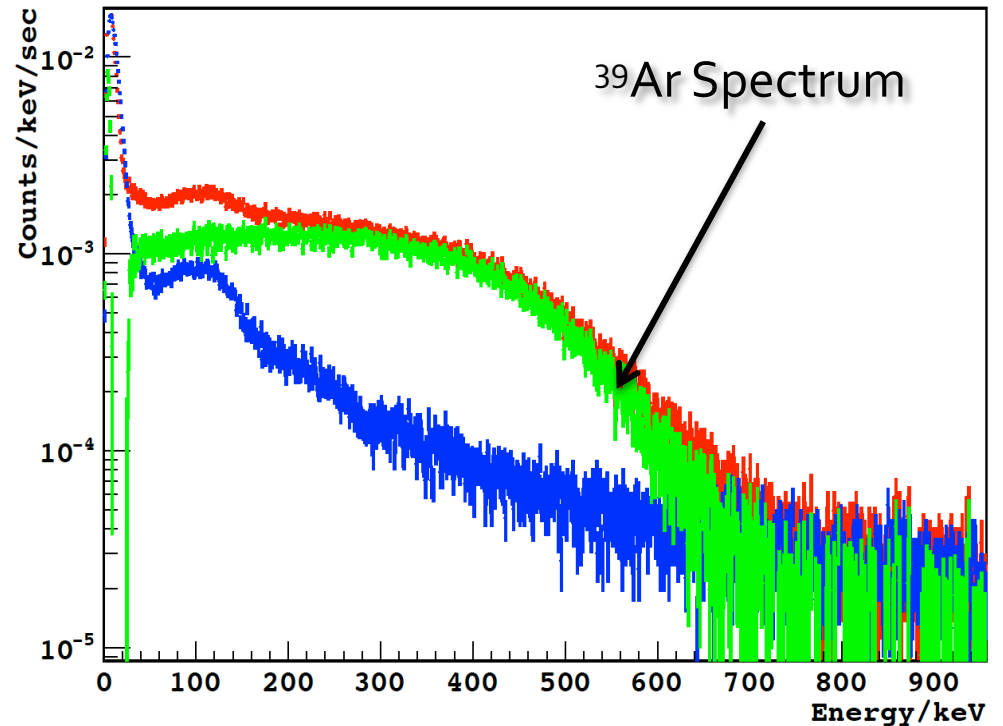

Underground Argon

- Underground argon is shielded, so can contain less ^{39}Ar
- CO_2 from Kinder Morgan Doe Canyon Complex (Cortez, CO) contains ~600 ppm Argon
 - 3 tons Ar produced/day
- ~75 kg of argon collected so far



For details: NIM A **587**:46-51 (2008),
AIP Conf. Proc. 1338:217-220 (2011)

Underground Argon Counting

The "Low Background Detector"

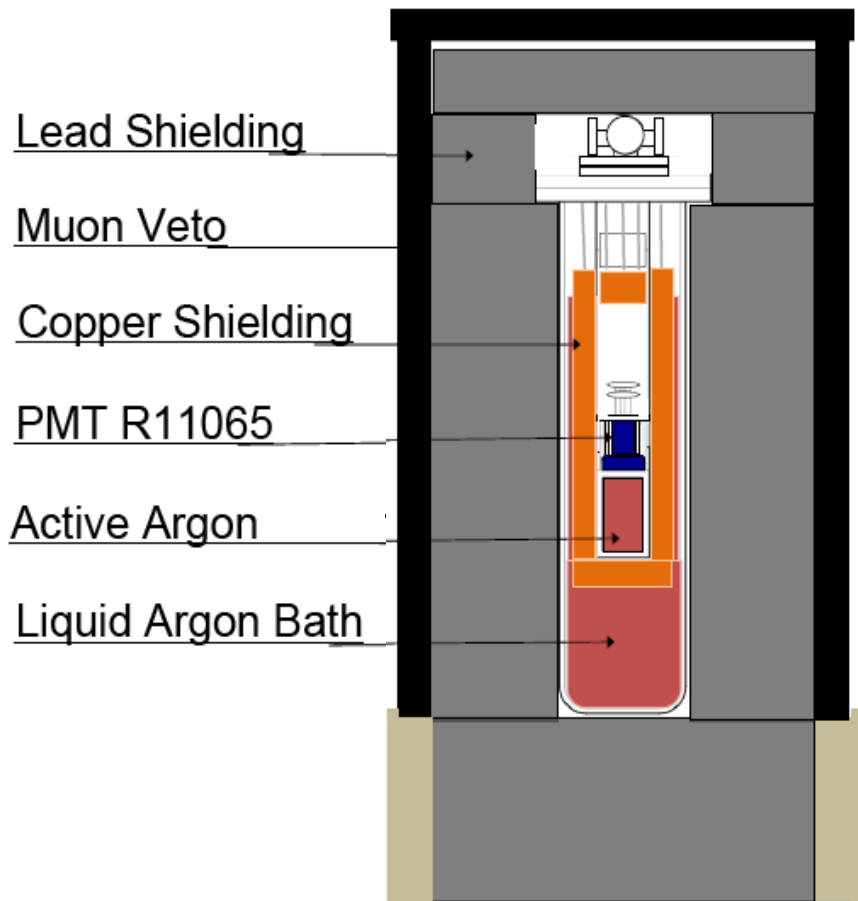

Underground Argon Counting

- Detector operated both on surface (Princeton) and underground (KURF, 1400 m.w.e.)
- Background rate of 0.002 Hz in 300-400 keV at KURF
- ^{39}Ar depletion factor >100

Multi-ton argon experiments possible with underground argon!

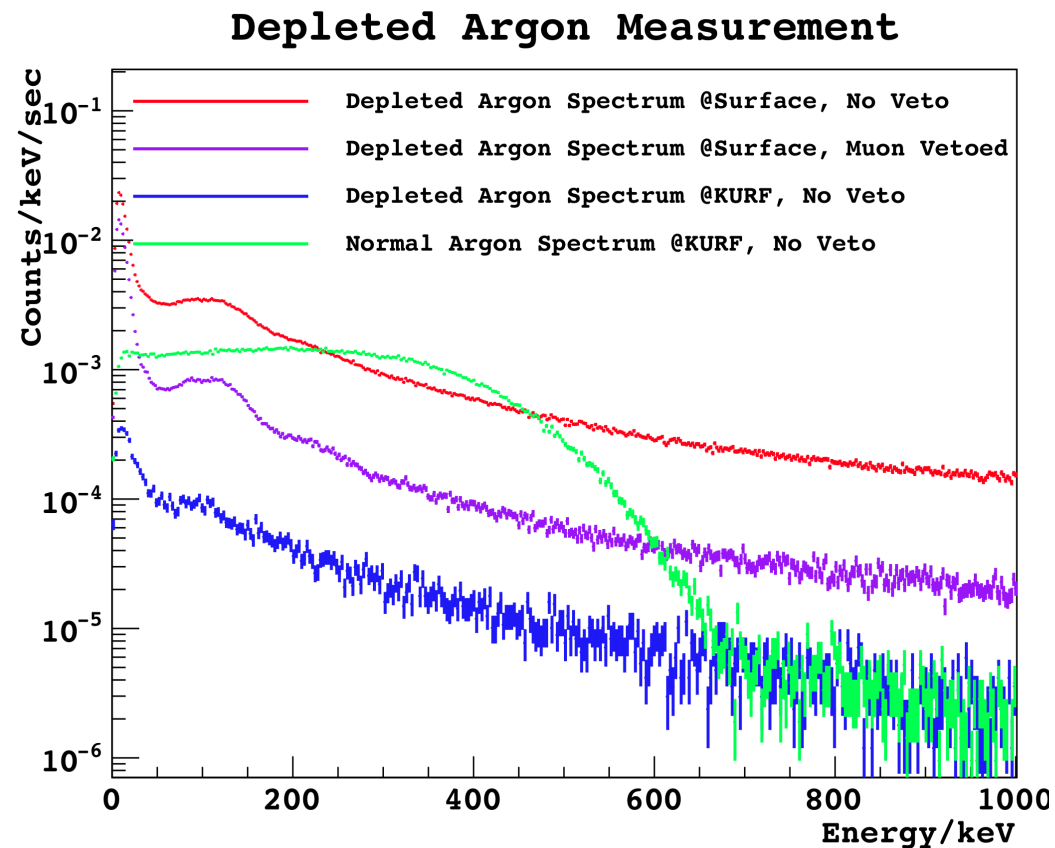

Highly-Efficient Neutron Veto

- Neutron scattering events can be a “perfect” WIMP background
- Surround DarkSide with boron-loaded liquid scintillator
- Efficiently detect escaping neutrons and veto any associated nuclear recoil backgrounds
 - >99.5% efficiency for radiogenic neutrons
 - >95% efficiency for cosmogenic neutrons

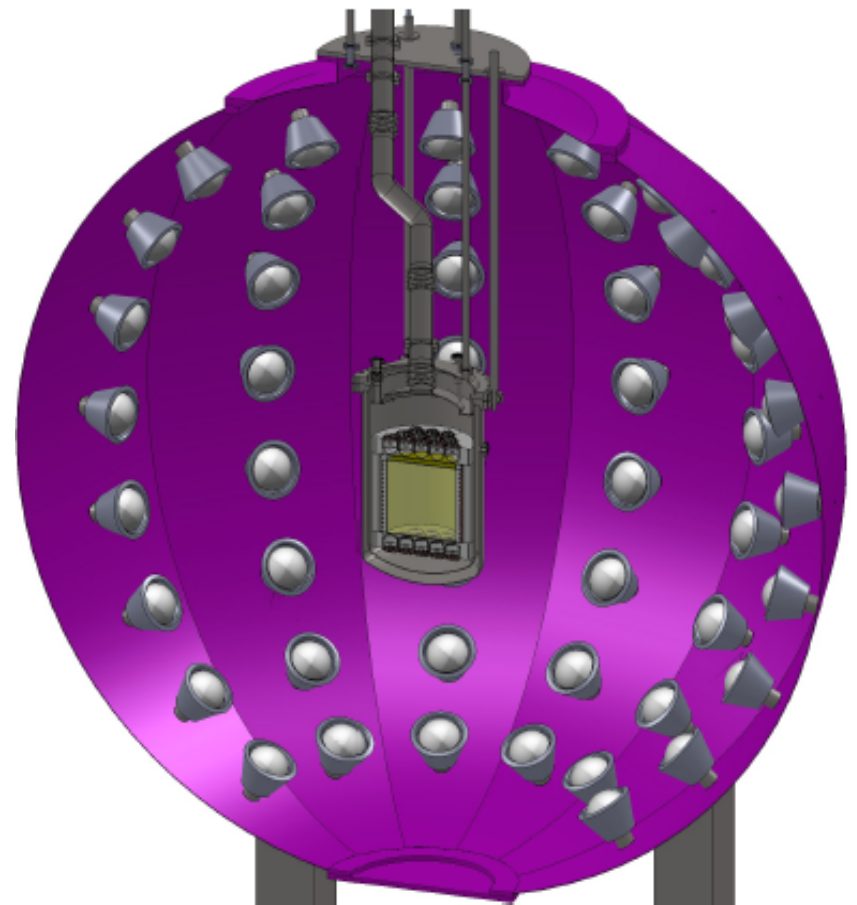

Cosmogenic Neutrons

- Install DarkSide within the Borexino CTF tank in LNGS, Italy
 - Muon flux reduced by 10^6
- Detect the Cerenkov light produced by the muons and other shower particles
 - Veto the neutron-induced background events
- CTF tank + neutron veto reduce cosmogenic backgrounds by $\gg 10^3$

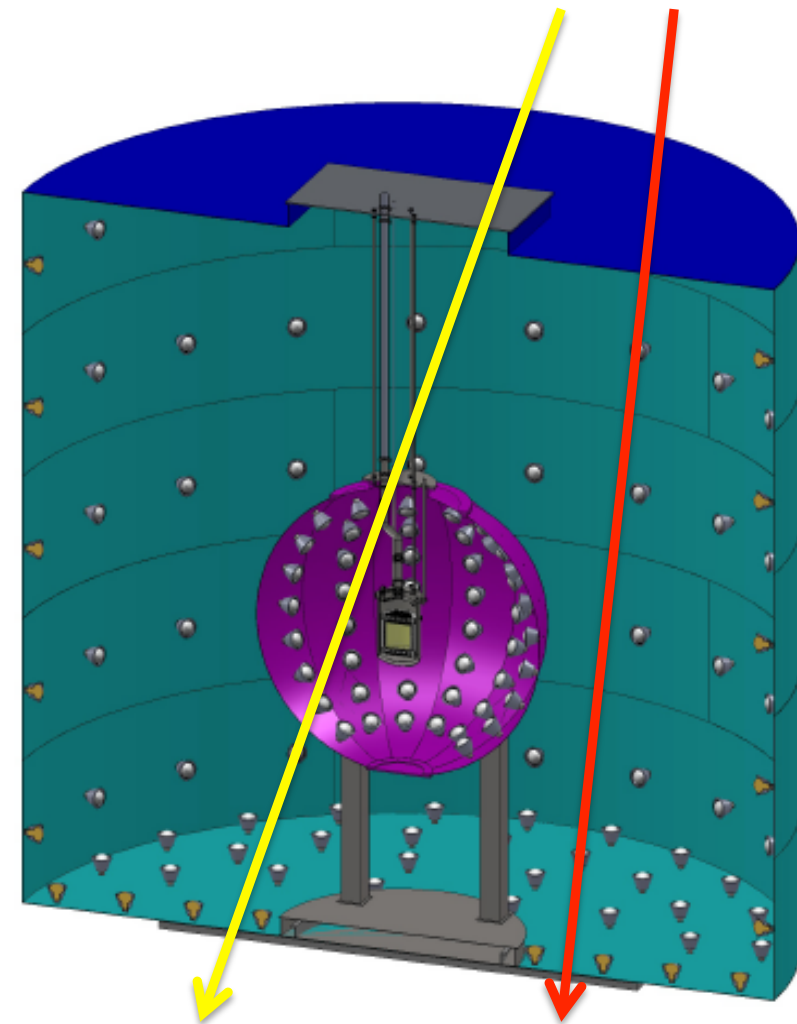

DarkSide-50 Background Estimates

Total WIMP background in (ev / 0.1 tonne-yr) for R11065 (QUPIDs):

Detector Element	Electron Recoil Backgrounds		Radiogenic Neutron Recoil Backgrounds		Cosmogenic Neutron Recoil Backgrounds	
	Raw	After Cuts	Raw	After Cuts	Raw	After Cuts
³⁹ Ar (<0.01 Bq/kg)	$<6.3 \times 10^6$	$<4 \times 10^{-3}$	–	–	–	–
Fused Silica	3.3×10^4	2.0×10^{-5}	0.17	4.3×10^{-4}	0.21	1.3×10^{-5}
PTFE	4,800	3.0×10^{-6}	0.39	9.8×10^{-4}	2.7	1.6×10^{-4}
Copper	4,500	2.8×10^{-6}	5.0×10^{-3}	1.3×10^{-5}	1.5	9.0×10^{-5}
R11065 PMTs	2.6×10^6	1.6×10^{-3}	19.4	4.8×10^{-2}	0.34	2.0×10^{-5}
QUPIDs (1 mBq)	7.0×10^4	4.2×10^{-5}	0.31	7.8×10^{-4}	0.34	2.0×10^{-5}
Stainless Steel	5.5×10^4	3.4×10^{-5}	2.5	6.3×10^{-3}	30	0.0018
Veto Scintillator	70	4.3×10^{-8}	0.030	7.5×10^{-5}	26	0.0016
Veto PMTs	2.5×10^6	1.6×10^{-3}	0.023	5.8×10^{-5}	–	–
Veto tank	1.7×10^5	1.1×10^{-4}	6.7×10^{-5}	1.7×10^{-7}	19	0.0071
Water	6,100	3.8×10^{-6}	6.7×10^{-4}	1.7×10^{-6}	19	0.0071
CTF tank	8,300	5.1×10^{-6}	3.5×10^{-3}	8.7×10^{-6}	0.068	2.6×10^{-5}
LNGS Rock	920	5.7×10^{-7}	0.061	1.5×10^{-4}	0.31	0.012
Total	–	0.007 (0.006)	–	0.055 (0.008)	–	0.030 (0.030)

Surface Backgrounds	
Raw	After cuts
4.5×10^3	<0.01

Very conservative estimates: DarkSide should demonstrate background free ton-yr exposures!

DarkSide-50 Physics Reach

- Background free operation for 0.1 tonne-yr gives 10^{-45}cm^2 sensitivity
- Background measurement from active suppression gives precise understanding of residual background rate
 - Credible detection claim possible based on a few observed events!

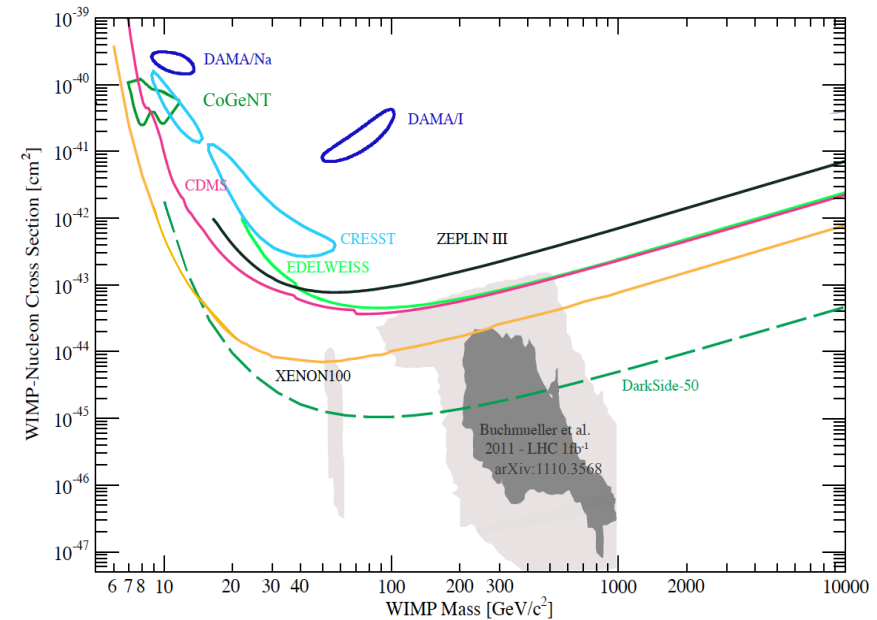

Detector commissioning expected in late 2012.

DarkSide-10 Prototype

- Test key technical concepts for DarkSide-50
- Practice running a 2-phase TPC, investigate backgrounds
- 12+ months of operation since 2010
- Initial runs at Princeton, now running underground at LNGS

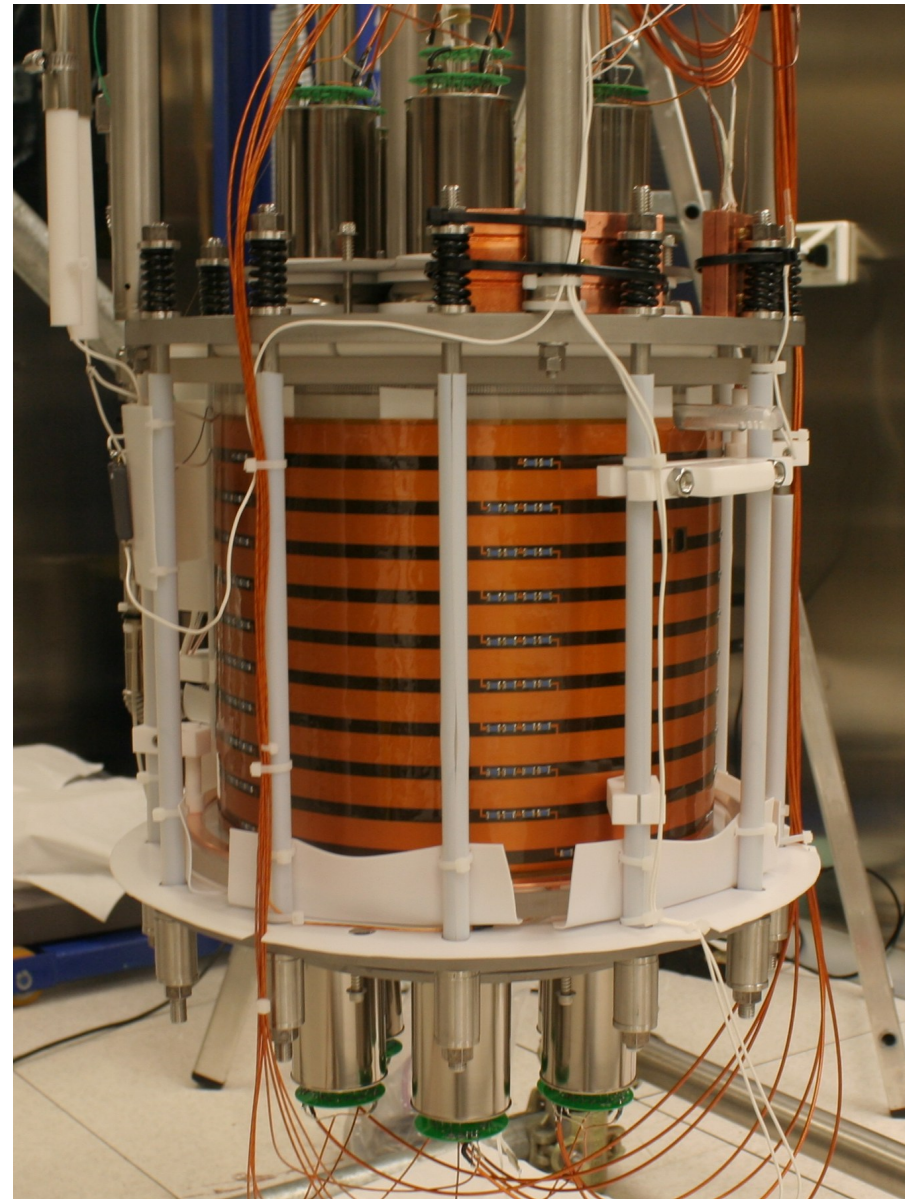

DarkSide-10 Prototype

- Test key technical concepts for DarkSide-50
- Practice running a 2-phase TPC, investigate backgrounds
- 12+ months of operation since 2010
- Initial runs at Princeton, now running underground at LNGS

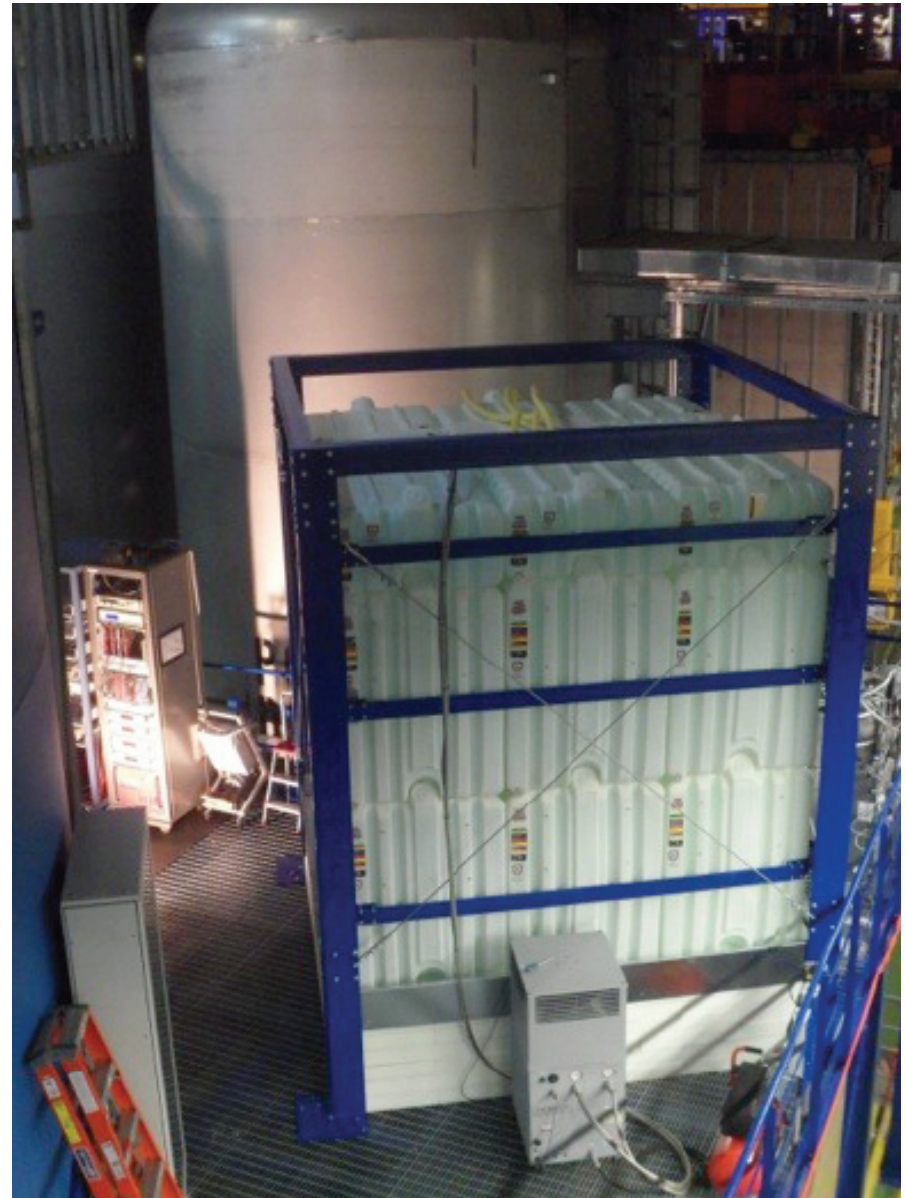

Two-Phase Operation!

Gamma Source:

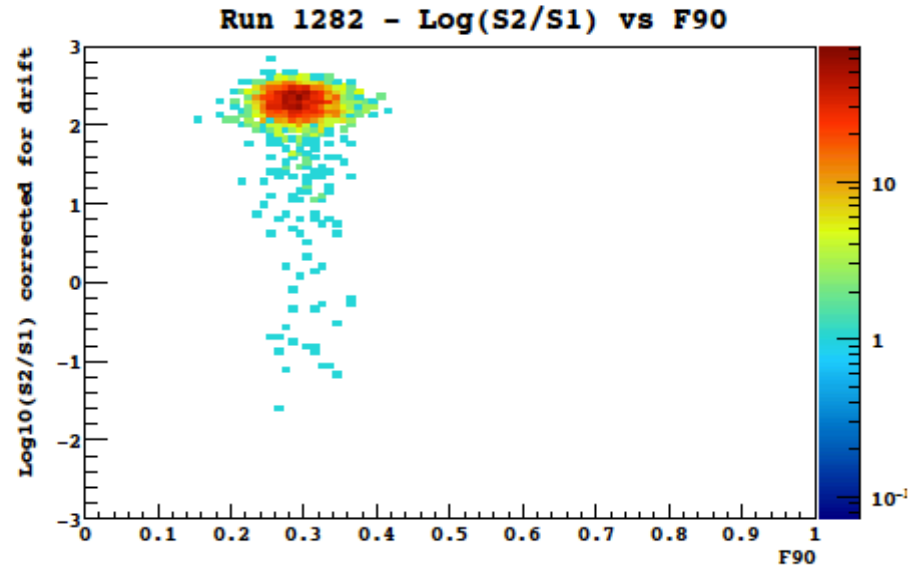

Neutron Source:

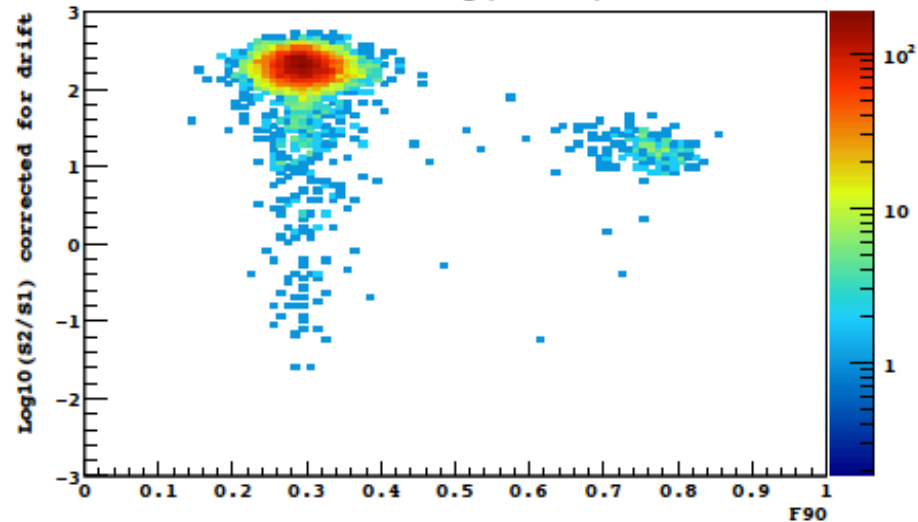

Light Yield

9.0 ± 0.1 p.e./keV!

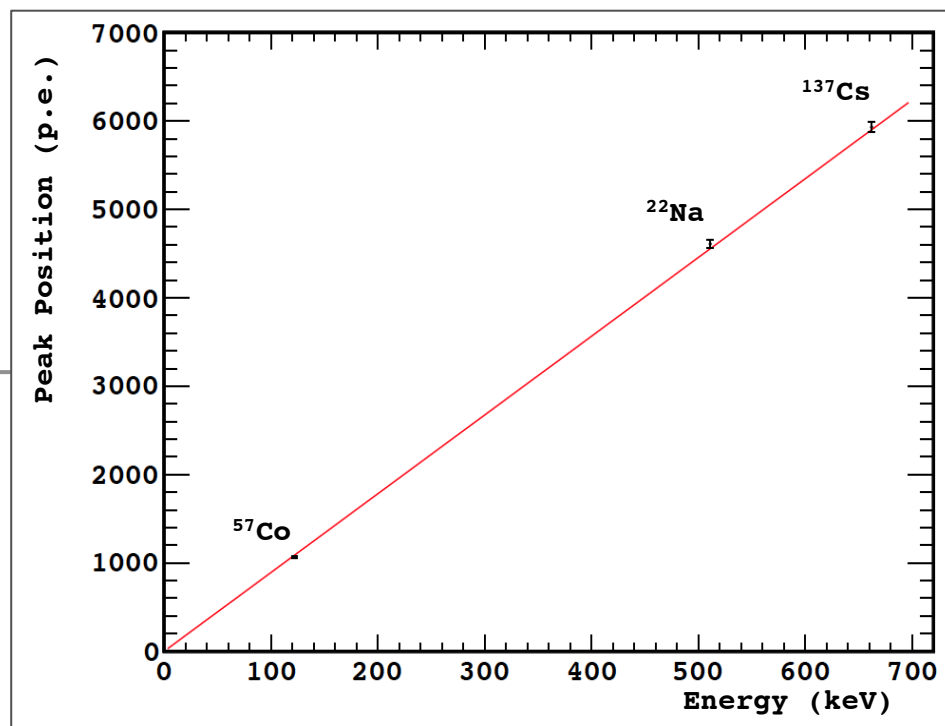
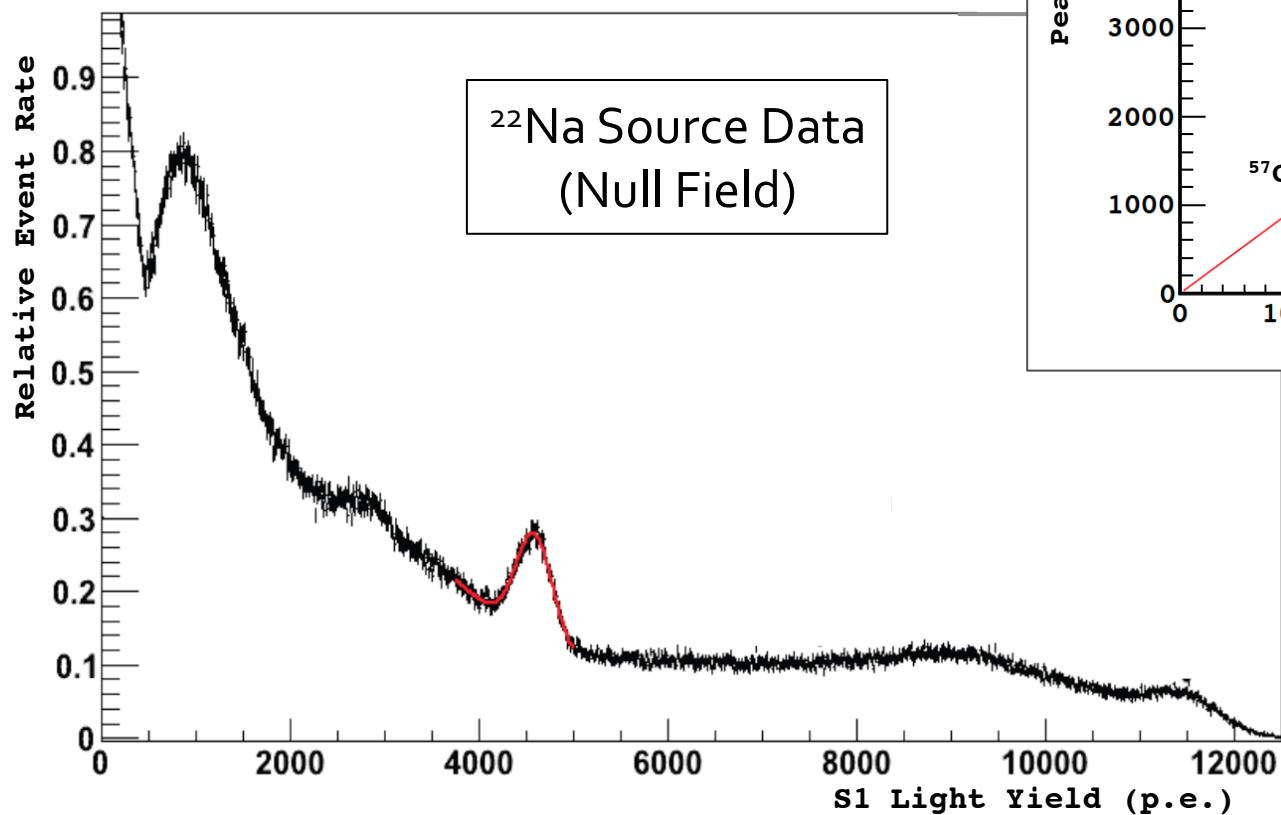

Shielded Operation

Event Rate in DarkSide-10 (without PSD)

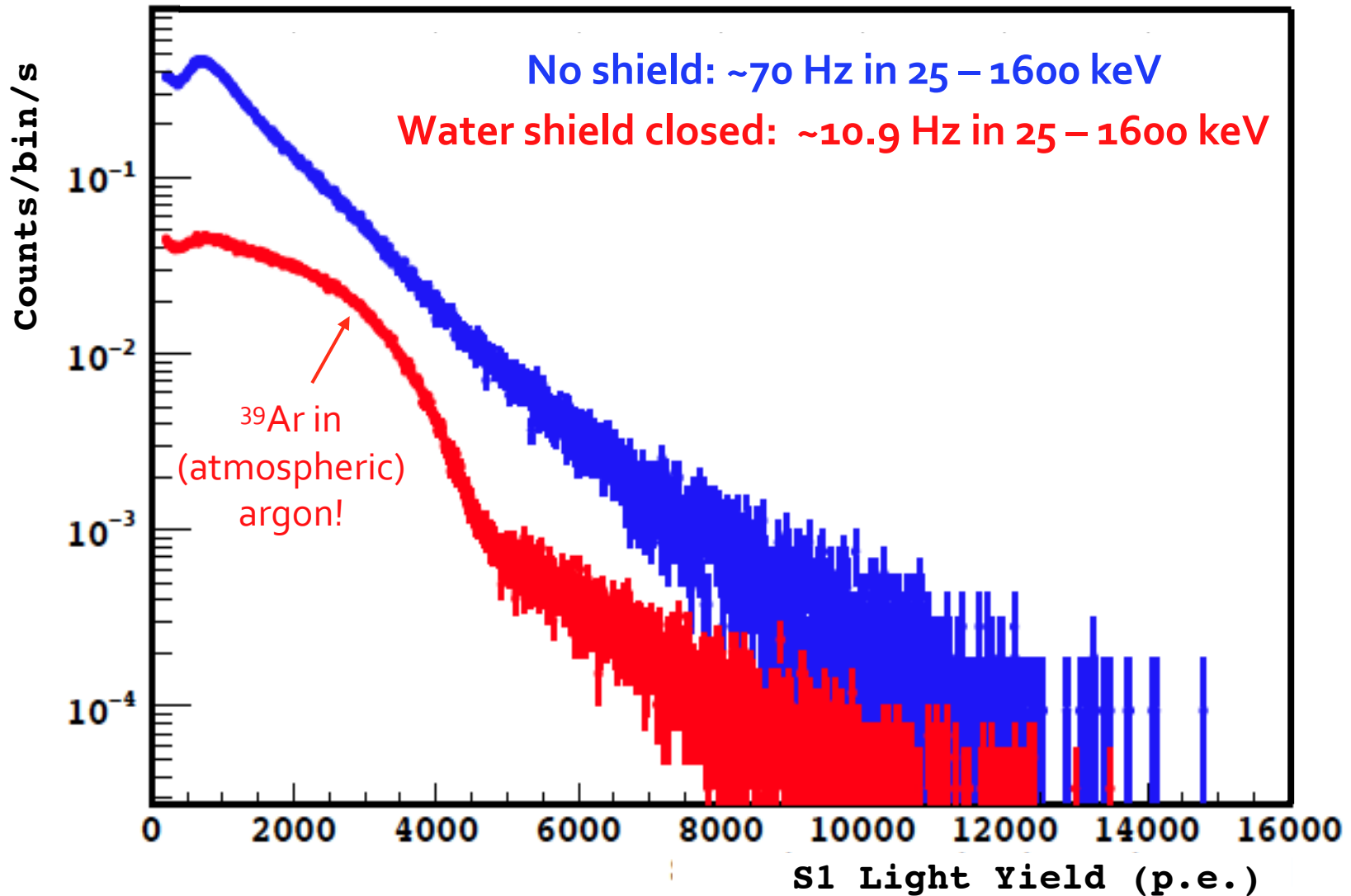

DarkSide Future

- Continued DarkSide-10 operation to gain experience with 2-phase operation, study backgrounds
- DarkSide-50 to deploy later this year
 - Reach 10^{-45} cm^2 in 3 years background free operation
- Tonne-scale experiment could reach 10^{-47} cm^2 using the same active shielding as DarkSide-50

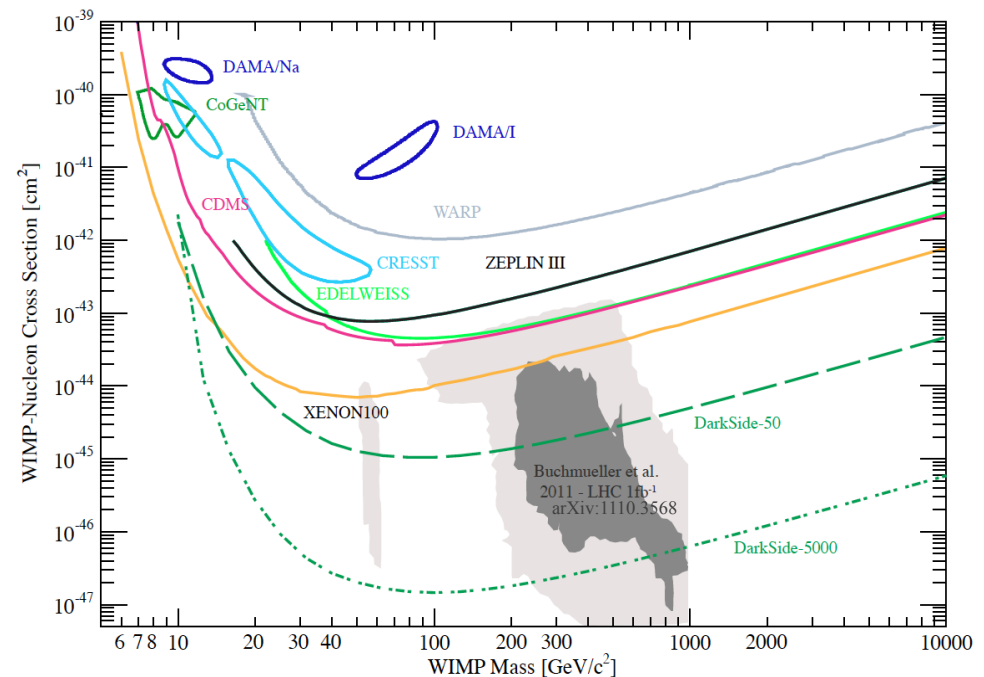

Testing DAMA

- The DAMA experiment observes an annual modulation
 - $>8\sigma$ effect
 - Amplitude $\sim 1\%$
 - Period consistent with 1 yr
 - Phase peaks May 19 – June 2
- DAMA collaboration attributes the oscillation to WIMP interactions
 - Phase agrees with June 1-2 predicted maximum for dark matter
- The WIMP interpretation is not widely accepted
 - Tension with other dark matter experiments
- So far, no definitive alternate explanation

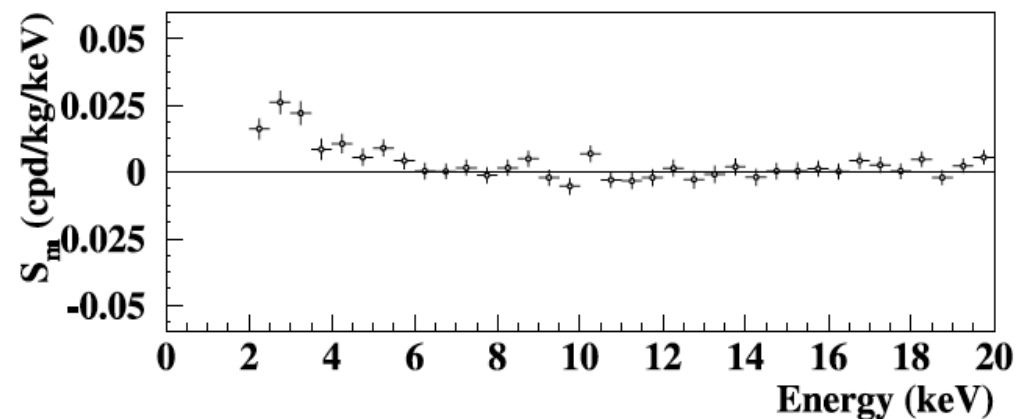
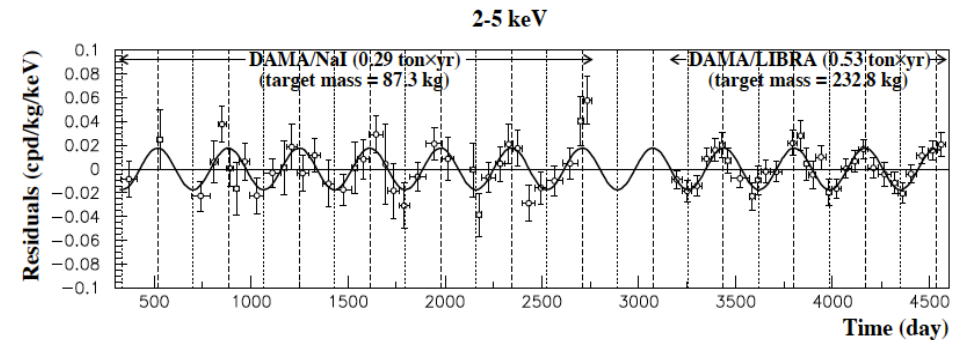

Testing DAMA

- The DAMA experiment observes an annual modulation
 - $>8\sigma$ effect
 - Amplitude $\sim 1\%$
 - Period consistent with 1 yr
 - Phase peaks May 19 – June 2
- DAMA collaboration attributes the oscillation to WIMP interactions
 - Phase agrees with June 1-2 predicted maximum for dark matter
- The WIMP interpretation is not widely accepted
 - Tension with other dark matter experiments
- So far, no definitive alternate explanation

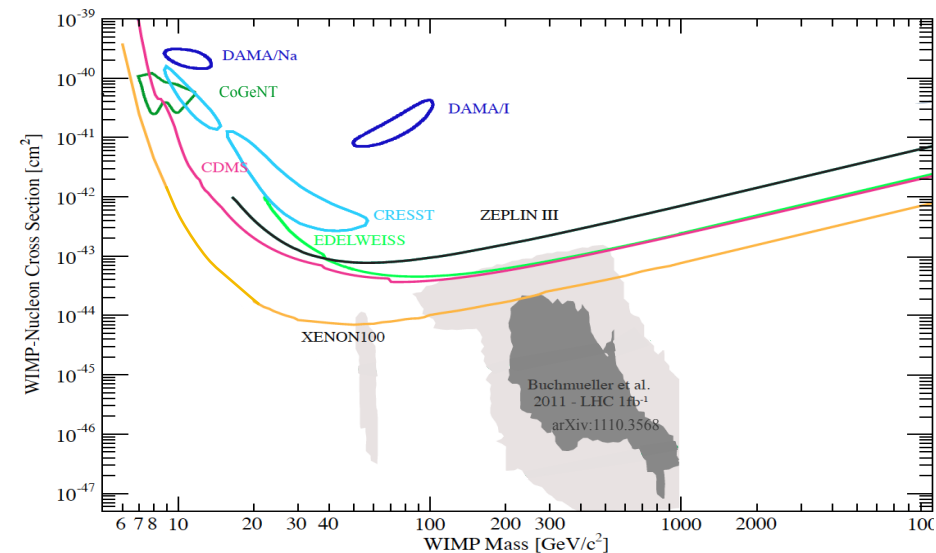

Testing DAMA

- To definitively test DAMA need NaI experiment with lower, better controlled backgrounds
 - 'Bump' at 3keV from K x-rays and Auger electrons following ^{40}K electron capture
 - Source of continuum at $\sim 1\text{cpd/kg/keV}$ unclear
 - Internal NaI backgrounds too low
 - Maybe background from (glass) PMTs?

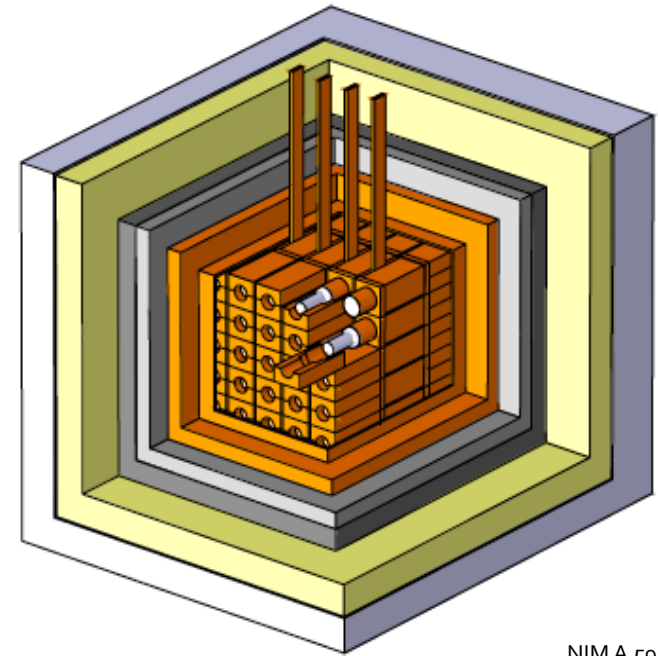

NIMA 592:297 (2008)

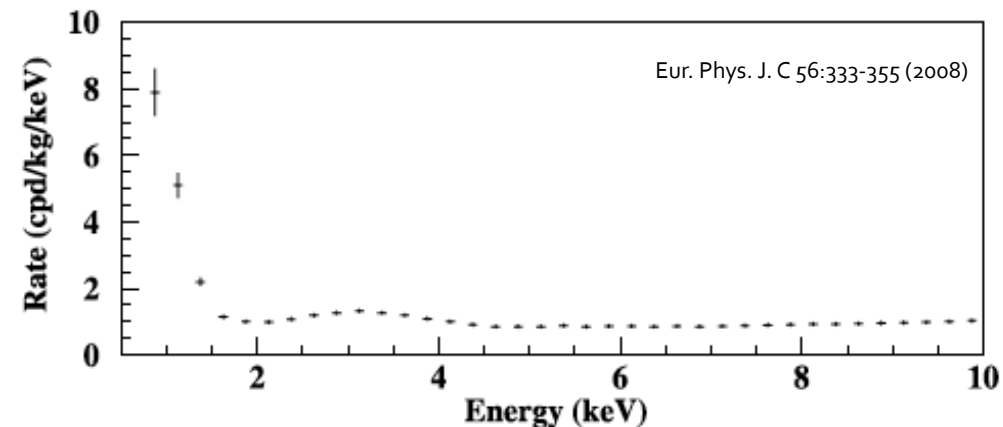

Testing DAMA

- Suspend the NaI in a scintillator veto
 - Completely controlled background environment
 - Scintillator can be much cleaner than passive shielding
 - Suppress ^{40}K backgrounds (PMT gammas) by factors of 10 (30) using the veto anti-coincidence
 - New metal bulb PMTs further reduce backgrounds (<0.002 cpd/keV/kg after veto)
- SNOLAB
 - ~100 times lower muon rate

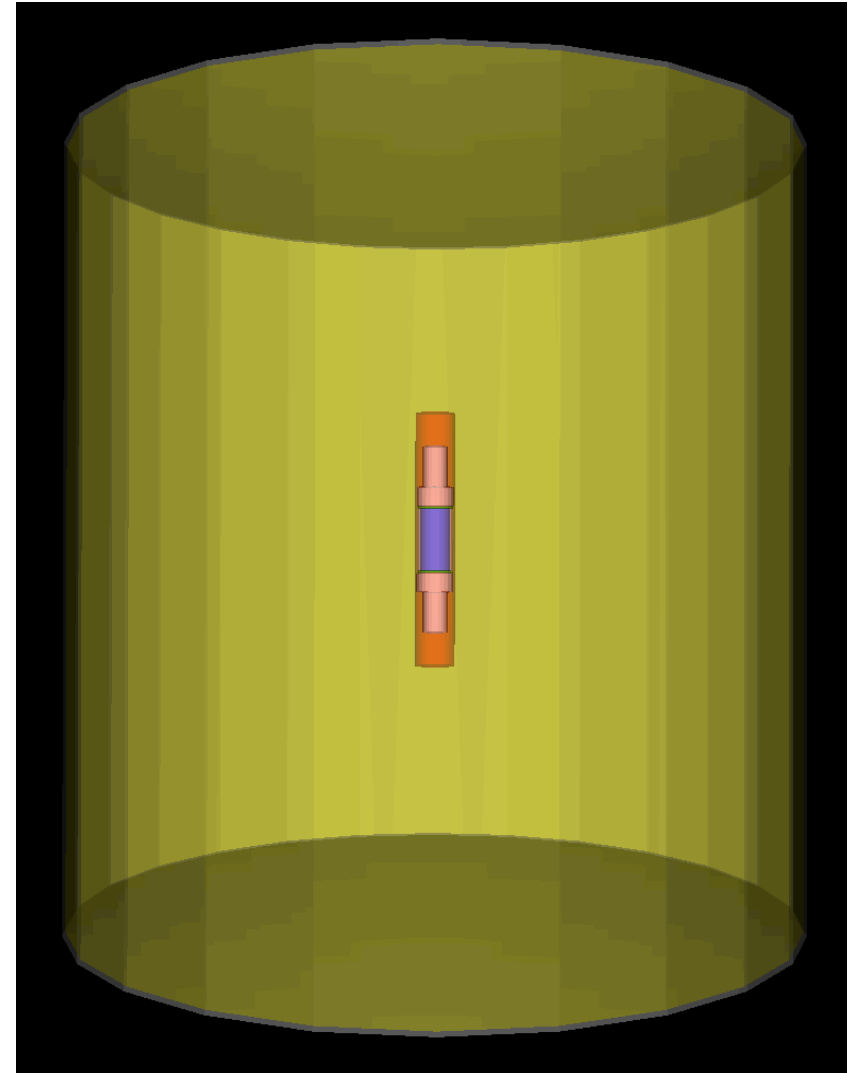

Testing DAMA

- SNOLAB
 - ~100 times lower muon rate
- Suspend the NaI in a scintillator veto
 - Completely controlled background environment
 - Scintillator can be much cleaner than passive shielding
 - Suppress ^{40}K backgrounds (PMT gammas) by factors of 10 (30) using the veto anti-coincidence
 - New metal bulb PMTs further reduce backgrounds (<0.002 cpd/keV/kg after veto)

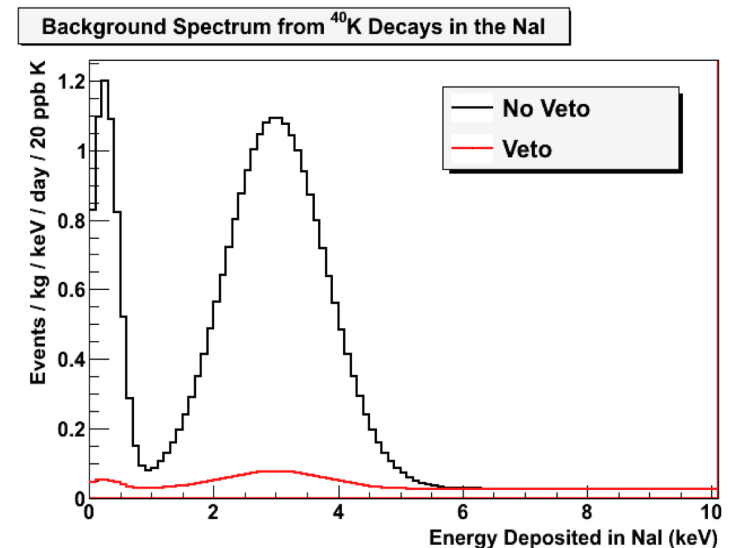

*Reducing background by a factor of 10 changes
a 2% modulation into a 20% modulation!*

Testing Dama

- Need clean NaI!
 - <20 ppb K, <10 ppt U & Th
- DAMA crystal purification procedure (San Gobain) is proprietary
- Working with industry to develop our own NaI purification techniques
 - Promising results from first purification tests
 - Improved techniques to assay K in NaI developed
 - Clean crystal growth being investigated
- Clean NaI will (finally!) allow a direct test of DAMA

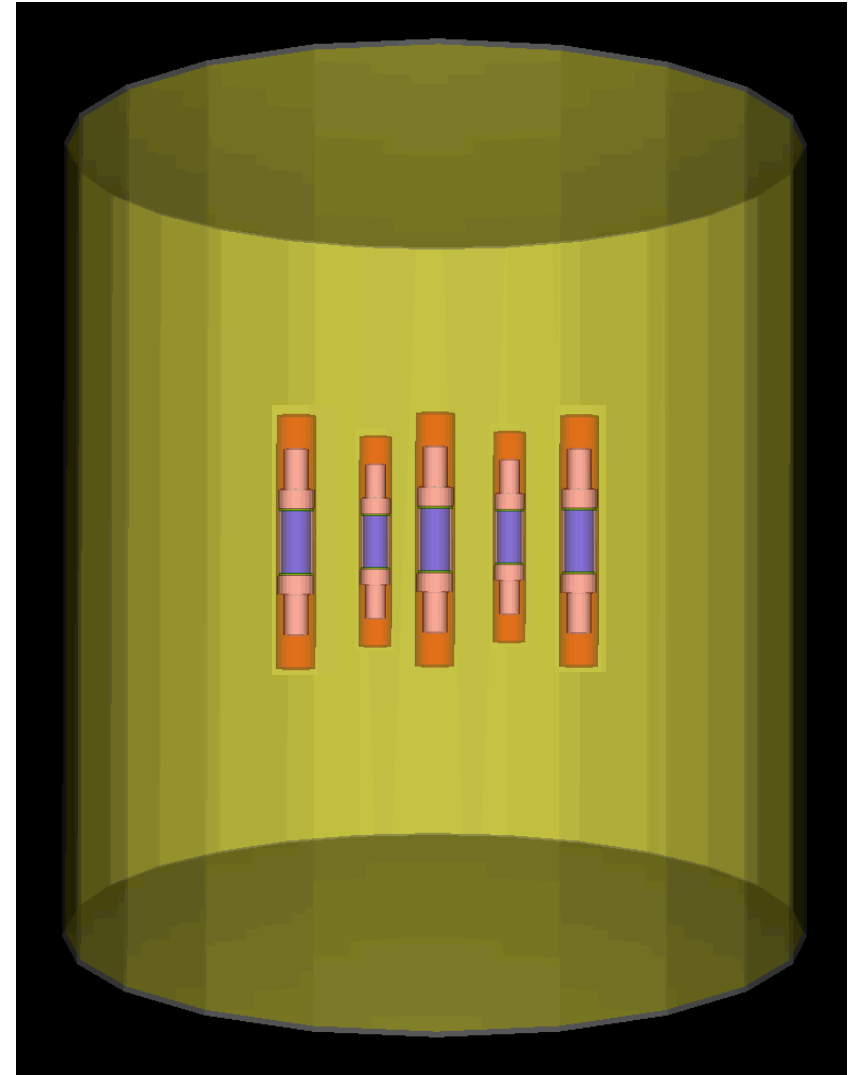

Hope for positive results by summer!

Dark Matter at Cornell

- Continue with argon-based dark matter searches
 - DarkSide-50, planning for DarkSide-5T, in the near term
 - Discovery potential in the heart of “WIMP Miracle” parameter space
 - Good chance of consolidation within the global (argon) dark matter program in the next few years
 - DarkSide technology will play a key role in eventual multi-tonne detector(s)
- Test the DAMA annual modulation
 - Finally a model-independent test of this intriguing result